

Guaranteed Through Innovation

Uken[®]
Professional Tools





Uken[®]

Professional Tools

ABOUT US

Uken Professional Tools. The firm has been engaged in supply of extremely good quality Tools & Industrial Products since the past few years. Yet, it has remained a clear winner satisfying all customer needs. At Uken, our professionally qualified & experienced workmen are employed who are extremely dedicated and talented in their respective domains.

All Tools & Industrial Products offered by the firm are the best in its class owing to its quality, workmanship, efficient performance, attractive looks, accuracy and fine finish. To maintain the quality of the products the firm is very particular in procuring the best quality of components only from the most trusted vendors. Our team of technical professionals are entrusted to take care of various stages of quality control, packing, delivery, etc. from start to finish.

Our Team

Our organization is backed by a dedicated team of skilled workforce and diligent personnel who are extremely competent to offer high quality products, and as well are

able to meet specific requirements of clients. Our team remains aware with respect to all the advancements & modern techniques that come into play from time to time.

The team possesses immense expertise owing to them being highly trained and experienced in their respective domains, which enables products & delivery of quality Tools within scheduled time periods. Regular trainings for our craftsmen and professionals are encouraged to update their skills with latest technology and developments in the industry. This ensures the organization remains in a position to deliver the attributes of a product offered by the firm.

Our Infrastructure:

The sophisticated infrastructure and our team of professionally qualified & experienced workmen account for systematic execution of all processing activities to meet all bulk demands.

Contact Us: info@ukentools.com
 Website: www.ukentools.com

EXPLANATION OF ABBREVIATIONS

AWG	AMERICAN WIRE GAUGE NUMBER
ABS	ANTI-LOCK BRAKING SYSTEM
CTN	CARTON BOX
CM	CENTIMETER
CR-V	CHROMIUM-VANADIUM STEEL
CR-MO	CHROMIUM-MOLYBDENUM STEEL
CR-NI	CHROMIUM-NICKEL STEEL
DIA / D	DIAMETER
DIN	GERMAN STANDARD

G	GRAM
H/D	HEAVY DUTY
L / L1 / L2	LENGTH
LB	POUND
MM	MILLIMETER
MTR	METER
HRC 54-54	ROCKWELL HARDNESS
NIOSH	NATIONAL INSTITUTE FOR OCCUPATIONAL SAFETY AND HEALTH

OZ	OUNCE
PKT	PACKET
PCS	PIECES
SS	STAINLESS STEEL
S	SHANK
TPR	THERMO PLASTIC RUBBER
W	WATTS
6"	6 INCH
500A	AMPS

Contents



MEASURING TOOLS **05**



INTERIOR AND FINISHING TOOLS **15**



HAND TOOLS **33**



ABRASIVES / CIRCULAR SAW BLADES /
DIAMOND BLADES **98**



DRILL BITS & ROUTER BITS **109**



SAFETY PRODUCTS **121**



WELDING PRODUCTS **134**



HOSE CLIPS **137**



LIFTING EQUIPMENTS **138**



CASTER WHEELS **144**

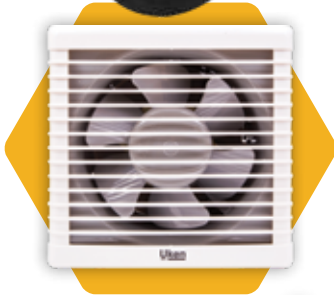

ELECTRICAL PRODUCTS **148**



FASTENERS **150**



HARDWARE SOLUTIONS **152**



MEASURING TAPE CHROME WITH RUBBER PROFESSIONAL

Chrome case with overmold holds up to heavy use

Ergonomic and compact design, the design of the tape manufactured comes with an Auto Lock System at the length to which it is extended to the customizable hook system.

25 MM - wide blade for easy readability

Cushion grip provides comfortable, slip-resistant hold

HIGHLIGHTS

- Chrome
- Thicker Blade
- Shock Proof
- Rubberised
- Clear Graduation
- Attractive Appearance
- Excellent Lock System

PART NO	DESCRIPTION	PCS / PKT	PCS / CTN
U8G4504	8 MTR X 25 MM	6	60



MEASURING TAPE - CLASSIC



HIGHLIGHTS

- Chrome
- Rubberized
- Nylon Coated
- Shock Proof
- Magnetic
- Thicker Blade
- Creative Design

PART NO	DESCRIPTION	PCS / PKT	PCS / CTN
U2000	3 MTR X 16 MM	12	60
U2001	5 MTR X 19 MM	6	60
U2002	7.5 MTR X 25 MM	6	60
U2003	10 MTR X 25 MM	6	60

MEASURING TAPE - YELLOW

HIGHLIGHTS

- ABS Case
- Clear Graduation
- Shock Proof
- Thicker Blade
- Popular Design
- Excellent Locking System



PART NO	DESCRIPTION	PCS / PKT	PCS / CTN
U3G48WY	3 MTR X 16 MM	12	120
U5X19G48XY	5 MTR X 19 MM	12	60
U5G48XY	5 MTR X 25 MM	12	60

MEASURING TAPE CHROME PROFESSIONAL

Auto lock system made for long life & blade control



Ergonomic and compact design fits beautifully in the hand and offering more easy handling.

HIGHLIGHTS

- Chrome
- Shock Proof
- Clear Graduation
- Thicker Blade
- Excellent Lock System

PART NO	DESCRIPTION	PCS / PKT	PCS / CTN
U3G48WC	3 MTR X 16 MM	12	120
U5X19G48XC	5 MTR X 19 MM	12	60
U5G48XC	5 MTR X 25 MM	12	60
U7HG48XC	7.5 MTR X 25 MM	6	60



MEASURING TAPE - YELLOW WITH RUBBER



HIGHLIGHTS

- ABS Case with rubber
- Thicker Blade
- Shock Proof
- Excellent Locking System
- Clear Graduation

PART NO	DESCRIPTION	PCS / PKT	PCS / CTN
U8G4503	8 MTR X 25 MM	6	60

MEASURING TAPE - GREEN CASE



HIGHLIGHTS

- ABS Case
- Shock Proof
- Popular Design
- Excellent Locking System
- Clear Graduation
- Rubber Coat

PART NO	DESCRIPTION	PCS / PKT	PCS / CTN
U10752	10 MTR X 25 MM	6	48

MEASURING TAPE - RUBBER

HIGHLIGHTS

- ABS Case with rubber
- Thicker Blade
- Shock Proof
- Excellent Locking System
- Clear Graduation

PART NO	DESCRIPTION	PCS / PKT	PCS / CTN
U3G53WR	3 MTR X 16 MM	12	120
U5X19G3XR	5 MTR X 19 MM	12	60
U5G53XR	5 MTR X 25 MM	12	60
U7HG53XR	7.5 MTR X 25 MM	6	60
U8G53XR	8 MTR X 25 MM	6	60



MEASURING TAPE - OPEN TYPE (STEEL)

HIGHLIGHTS

- Open body frame with rubberised handle
- Rewind handle for fast retraction
- Thicker blade steel



PART NO	DESCRIPTION	PCS / PKT	PCS / CTN
UJ306	30 MTR X 13 MM	1	50
UJ506	50 MTR X 13 MM	1	50

MEASURING TAPE - CLOSE TYPE (FIBER)

HIGHLIGHTS

- Heavy duty case with soft rubber grip
- Rewind handle for fast retraction
- Reinforced pull ring



PART NO	DESCRIPTION	PCS / PKT	PCS / CTN
U2011	15 MTR X 13 MM	1	60
U2012	20 MTR X 13 MM	1	40
U2013	30 MTR X 13 MM	1	40
U2014	50 MTR X 13 MM	1	20

MEASURING TAPE - CLOSE TYPE (STEEL)



TPR cover for high grips



HIGHLIGHTS

- High quality & comfortable
- Clear graduation
- Thicker blade steel
- Rewind handle for fast retraction
- Rubberised

PART NO	DESCRIPTION	PCS / PKT	PCS / CTN
U30G50	30 MTR X 13 MM	1	30
U50G50	50 MTR X 13 MM	1	30

MEASURING TAPE - OPEN TYPE (FIBER)

HIGHLIGHTS

- Open body with rubberised handle
- Rewind handle for full retraction
- Clear Graduation



PART NO	DESCRIPTION	PCS / PKT	PCS / CTN
U2015	100 MTR X 13 MM	1	10

SS SCALE



HIGHLIGHTS

- Rust proof stainless steel scale
- Easy reading graduation
- Available in different sizes
- Endorsed conversion table

PART NO	DESCRIPTION	PCS / PKT	PCS / CTN
U28-030	30 CM	12	300
U28-060	60 CM	20	100
U28-100	100 CM	20	60
U28-120	120 CM	20	60
U28-150	150 CM	10	30
U28-200	200 CM	10	30

TRY SQUARE- HEAVY DUTY



HIGHLIGHTS

- Rust proof stainless steel scale
- Zinc handle heavy duty
- Easy reading graduation etched in to scale
- Available in different sizes

PART NO	DESCRIPTION	PCS / PKT	PCS / CTN
U29-015	6"	6	36
U29-020	8"	6	36
U29-025	10"	6	36
U29-030	12"	6	36

TRY SQUARE - PLASTIC HANDLE

HIGHLIGHTS

- Rust proof stainless steel scale.
- Plastic handle
- Easy reading graduation etched in to scale
- Available in different sizes



PART NO	DESCRIPTION	PCS / PKT	PCS / CTN
U32-020	8"	6	36
U32-025	10"	6	36
U32-030	12"	6	36

TRY SQUARE - ALUMINIUM HANDLE

HIGHLIGHTS

- Rust proof stainless steel scale.
- Aluminium handle
- Easy reading graduation etched in to scale
- Available in different sizes



PART NO	DESCRIPTION	PCS / PKT	PCS / CTN
U33-015	6"	10	90
U33-020	8"	10	90
U33-025	10"	10	60
U33-030	12"	10	60

COMBINATION SQUARE

The 12" combination square has a durable blade that features etched markings and brass thumbscrews along with a built-in bubble vial. The tool provides accurate measurements.

HIGHLIGHTS

- Aluminium alloy body construction
- Mechanical surface for greater accuracy
- Metric and imperial graduations etched in to scale

Embossed graduations for easy reading



Vial accuracy 0.55 mm/m for easy readability

PART NO	DESCRIPTION	PCS / PKT	PCS / CTN
U31-030	12"	10	60



Made of high quality steel and produced to the highest precision standards, makes them the most accurate and readable precision steel scales.

RIGHT ANGLE

HIGHLIGHTS

- Rust proof steel blade
- Used for laying out and marking angles in framing, roofing interior work for checking squareness and flatness



PART NO	DESCRIPTION	PCS / PKT	PCS / CTN
U30-030	12"	6	36
U30-060	24"	6	36

SPIRIT LEVEL



Magnified center vial for improved visibility

Strong and lightweight aluminium frame suitable for all purpose and durability

Milling surface to provide good accurate levels



Shock absorbing end cap

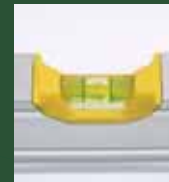

Magnified Center Vial



Rigid Box Beam Construction

Heavy duty aluminium beam frames and virtually unbreakable under normal conditions. The magnified vial with large bubble makes it easier to read accurately.

HIGHLIGHTS

- Heavy duty box aluminium frame
- 3 Solid block acrylic vials
- Protect frame milled working surface
- Shock absorbing end caps
- Vial accuracy 0.5 mm/m

PART NO	DESCRIPTION	PCS / PKT	PCS / CTN
U6412	12"	10	40
U6416	16"	10	40
U6424	24"	10	40
U6432	32"	10	40
U6436	36"	10	40

PART NO	DESCRIPTION	PCS / PKT	PCS / CTN
U6440	40"	10	20
U6448	48"	10	20
U6460	60"	10	20
U6472	72"	10	20
U6480	80"	10	20

SPIRIT LEVEL WITH MAGNET

HIGHLIGHTS

- Heavy duty box aluminium frame
- 3 Solid block acrylic vials
- Shock absorbing end caps
- Vial accuracy 0.5 mm/m

Strong holding
magnetic edges



PART NO	DESCRIPTION	PCS / PKT	PCS / CTN
U6512M	12"	10	40
U6516M	16"	10	40
U6524M	24"	10	40
U6532M	32"	10	40
U6536M	36"	10	40
U6540M	40"	10	20

SPIRIT LEVEL - PROFESSIONAL WITH MAGNET



HIGHLIGHTS

- Cast aluminium level with heavy duty frame
- Strong hold magnetic
- Milled working surface
- Vial accuracy 0.5 mm / m

PART NO	DESCRIPTION	PCS / PKT	PCS / CTN
U6510M	10"	10	60



SPIRIT LEVEL - PROFESSIONAL

HIGHLIGHTS

- Heavy duty box aluminium frame.
- Comfortable rubberized hand grip.
- Shock proof end caps.
- Vial accuracy 0.5 mm/m



PART NO	DESCRIPTION	PCS / PKT	PCS / CTN
U6612	12"	15	30
U6618	18"	15	30
U6624	24"	15	30
U6632	32"	10	20
U6640	40"	10	20
U6648	48"	10	20
U6672	72"	10	20
U6680	80"	6	12

SPIRIT LEVEL - PLASTIC - TORPEDO

HIGHLIGHTS

- Aluminium reinforced frame 9" torpedo level
- Top read window for easy viewing
- Strong magnetic edge
- Vial accuracy 0.5 mm / m



PART NO	DESCRIPTION	PCS / PKT	PCS / CTN
U6509M	9"	12	180

CHALK LINE REEL



HIGHLIGHTS

- High visibility
- Streamlined ergonomic shape
- Durable impact resistant case

PART NO	DESCRIPTION	PCS / PKT	PCS / CTN
U46001	30 M Chalk Line Reel	6	60

CHALK LINE REFILL



HIGHLIGHTS

- High visibility
- Streamlined ergonomic shape
- Durable impact resistant case

PART NO	DESCRIPTION	PCS / PKT	PCS / CTN
U46004	RED	10	100
U46005	BLUE	10	100

CHALK LINE REEL SET



HIGHLIGHTS

- High visibility
- Streamlined ergonomic shape
- Durable impact resistant case

PART NO	DESCRIPTION	PCS / PKT	PCS / CTN
U46002	30 M Chalk Line Reel with 113 gm Blue Chalk	6	36

CHALK LINE REEL SET WITH LEVEL



HIGHLIGHTS

- High visibility
- Streamlined ergonomic shape
- Durable impact resistant case
- Chalk line set with level

PART NO	DESCRIPTION	PCS / PKT	PCS / CTN
U46003	30 m Chalk Line Reel Set with level and 113 gm Blue Chalk	6	36

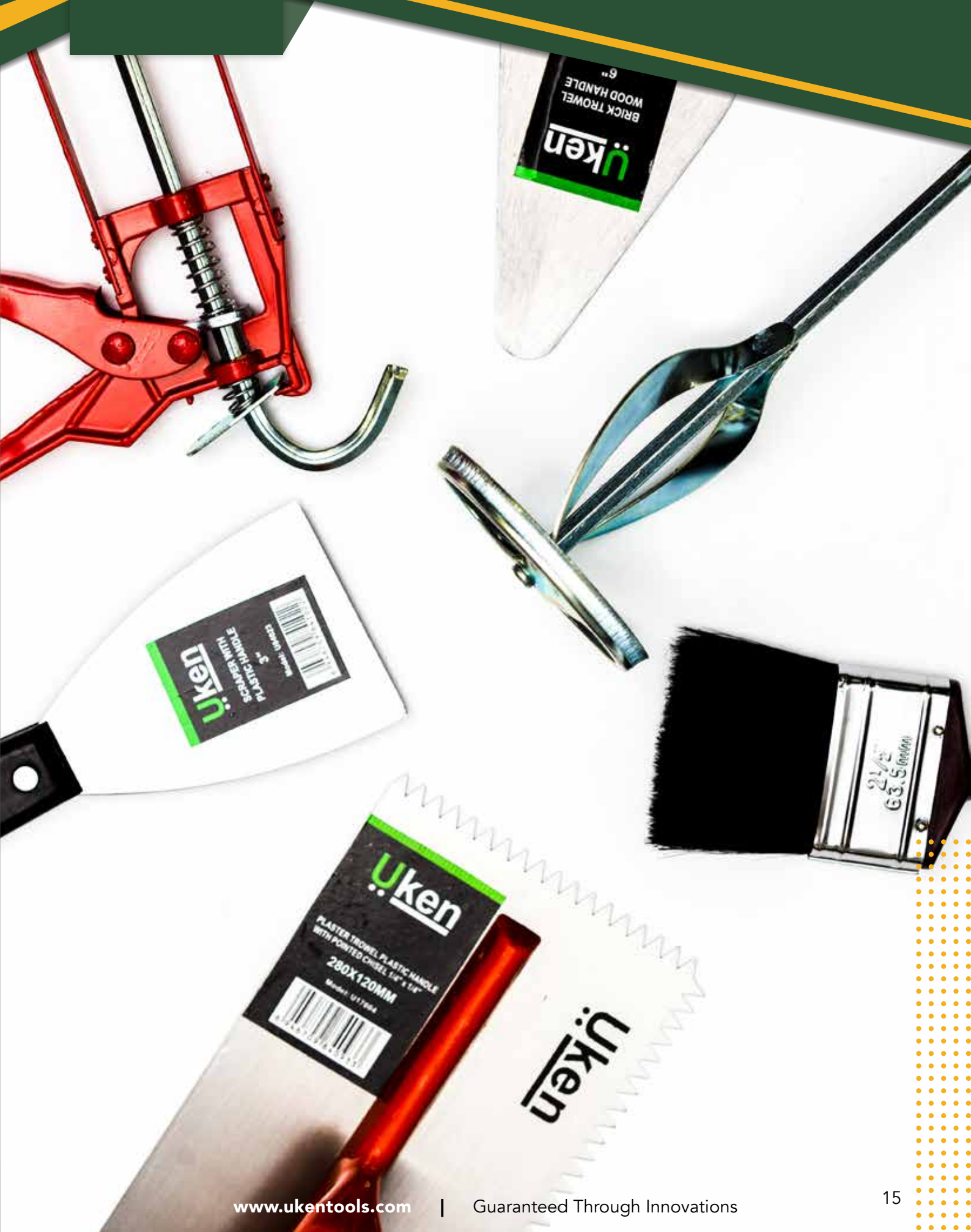

PAINT BRUSH BLACK

HIGHLIGHTS

- Pure bristles
- Suitable for all purpose
- Excellent for high productivity
- Provides good, smooth results in all paints

PART NO	DESCRIPTION	PCS / PKT	PCS / CTN
62805	1/2"	12	864
62810	1"	12	864
62815	1.5"	12	600
62820	2"	12	360
62825	2.5"	12	360
62830	3"	12	240
62840	4"	12	144
62850	5"	6	120
62860	6"	6	120



Black bristles, good softness and elastic, high pickup and release

PAINT BRUSH WHITE

HIGHLIGHTS

- Pure bristles
- Suitable for all purpose
- Wooden handle
- Excellent for high productivity
- Provides good, smooth results in all paints



PART NO	DESCRIPTION	PCS / PKT	PCS / CTN
27905	1/2"	20	720
27910	1"	20	500
27915	1.5"	20	300
27920	2"	20	200
27925	2.5"	10	160
27930	3"	10	120
27940	4"	5	100
27950	5"	5	60
27960	6"	5	40

ARTIST BRUSH

HIGHLIGHTS

- Provide good smooth results in all paints
- Uniform painting /easy clean and maintenance
- No elbow / No hand pain

PART NO	DESCRIPTION	PCS / PKT	PCS / CTN
U39286	FLAT 10PC SET - 2mm-2nos/ 4mm-2nos / 6mm-2nos/13mm - 4nos	10	200 SET
U39287	FLAT 5PC SET - 2mm/ 4mm/6mm/13mm - 2nos	10	200 SET
U39579	FLAT 12PC SET - 1mm, 2, 3, 4, 5, 6, 7, 8, 9, 10, 11, 12	12	72
U39582	ROUND HEAD 12PC SET - 1mm, 2, 3, 4, 5, 6, 7, 8, 9, 10, 11, 12	10	40





PAINT ROLLER - LONG PILE

HIGHLIGHTS

- Frame & Roller
- Perfect for rolling a large amount of new dry wall quickly
- Provide a smooth finish with less lint
- Plastic handle
- Long Pile



Superb blend polyster and knitted wool designed for maximum paint pickup and release.

PART NO	DESCRIPTION	PCS / PKT	PCS / CTN
UPR4	4"	1	40
UPR7	7"	1	40
UPR9	9"	1	36

PAINT ROLLER - SHORT PILE

HIGHLIGHTS

- Frame & Roller
- Perfect for rolling a large amount of new dry wall quickly
- Provides a smooth finish with less lint
- Plastic handle
- Short Pile



PART NO	DESCRIPTION	PCS / PKT	PCS / CTN
U2803	9"	1	40

PAINT ROLLER REFILL - SHORT PILE



PART NO	DESCRIPTION	PCS / PKT	PCS / CTN
U2804	9"	1	100



PAINT ROLLER - REFILL LONG PILE

PART NO	DESCRIPTION	PCS / PKT	PCS / CTN
UPRR4	4"	1	100
UPRR7	7"	1	100
UPRR9	9"	1	100

PAINT ROLLER - REFILL MOHAIR

PART NO	DESCRIPTION	PCS / PKT	PCS / CTN
U2801-9	9"	1	100

PAINT ROLLER - REFILL ACRYLIC

PART NO	DESCRIPTION	PCS / PKT	PCS / CTN
U2901-9	9"	1	100

PAINT ROLLER - MOHAIR

HIGHLIGHTS

- Frame & Roller
- Suitable for oil based paints
- Providing smoothest finish
- Roller work best with high gloss finishes and will distribute paint evenly creating a smooth finish on the wall



PART NO	DESCRIPTION	PCS / PKT	PCS / CTN
U2800-9	9"	1	40

PAINT ROLLER - ACRYLIC

HIGHLIGHTS

- Frame & Roller
- Provide the smoothest finish from any other roller
- Made of lint free premium fabric
- Fine finish covers help distribute evenly and make clean - up easy



PART NO	DESCRIPTION	PCS / PKT	PCS / CTN
U2900-9	9"	1	40

RADIATOR ROLLER REFILL



PART NO	DESCRIPTION	PCS / PKT	PCS / CTN
112004	4"	10	500



RADIATOR ROLLER

HIGHLIGHTS

- Frame & Roller
- Roller recommended for small, hard to reach areas and give the smoothest rolling action to make the job go faster
- Made of high density polyester fabric



PART NO	DESCRIPTION	PCS / PKT	PCS / CTN
111004	4"	1	120

RADIATOR ROLLER REFILL - FOAM TYPE



PART NO	DESCRIPTION	PCS / PKT	PCS / CTN
U2802	4"	10	400

SCRAPER 10"

Wood handle with rigged high steel blade for painting drywalls

Light natural wood handle for easy operations



Rigged high steel blade for heavy application

HIGHLIGHTS

- Square scraper with wooden handle
- Rigged high steel blade
- Comfort thump grip handle

PART NO	DESCRIPTION	PCS / PKT	PCS / CTN
U1200	10"	12	120
U1209	8"	12	120

SCRAPER - BLACK HANDLE



HIGHLIGHTS

- Rigid high steel blades
- Comfort thump with plastic handle

PART NO	DESCRIPTION	PCS / PKT	PCS / CTN
U04021	1"	12	240
U040215	1.5"	12	240
U04022	2"	12	240
U040225	2.5"	12	240
U04023	3"	12	240
U04024	4"	12	240



SCRAPER - WOOD HANDLE

HIGHLIGHTS

- Rigid steel blade with wooden handle
- Comfort thump grip handle



PART NO	DESCRIPTION	PCS / PKT	PCS / CTN
U1201	1"	12	240
U1202	1.5"	12	240
U1203	2"	12	240
U1204	2.5"	12	240
U1205	3"	12	240
U1206	4"	12	240
U1207	5"	12	240
U1208	6"	12	240

SCRAPER S.STEEL - GREEN HANDLE



Scraper knife is made of steel with plastic handle for soft and handy use and ensures slip resistance

HIGHLIGHTS

- Rigid high steel blade with plastic handle
- Easy to handle
- Stainless Steel

PART NO	DESCRIPTION	PCS / PKT	PCS / CTN
U05021	1"	12	240
U050215	1.5"	12	240
U05022	2"	12	240
U050225	2.5"	12	240
U05023	3"	12	240
U05024	4"	12	240

SCRAPER SET - PLASTIC



HIGHLIGHTS

- Plastic square scraper
- Comfort thump grip

PART NO	DESCRIPTION	PCS / PKT	PCS / CTN
U0705P	5, 8, 10, 12 (CM)	10 SET	200 SET

SCRAPER SET



HIGHLIGHTS

- Square scraper with plastic handle
- Comfort thump grip

PART NO	DESCRIPTION	PCS / PKT	PCS / CTN
U0704M	5, 8, 10, 12 (CM)	10 SET	200 SET

WINDOW SCRAPER



HIGHLIGHTS

- For scraping on all surfaces
- Comfortable plastic handle with detachable blade guard
- Easy to change blade

PART NO	PCS / INNER CTN	PCS / CTN
U6240	24	288



MASONRY TROWEL - HEAVY DUTY



HIGHLIGHTS

- Wooden handle
- Steel blade is temper ground and polished
- Balanced weight & flexible blade
- Suitable for small areas for patching

PART NO	DESCRIPTION	PCS / PKT	PCS / CTN
U1221	6"	12	120
U1222	7"	12	120
U1223	8"	12	120
U1224	9"	12	120

MASONRY TROWEL - HEAVY DUTY



HIGHLIGHTS

- Wooden handle
- Steel blade easy to use
- Tempered ground and polished for perfect balance
- Wide pattern bricky trowel carries more materials and is good for high productivity

PART NO	DESCRIPTION	PCS / PKT	PCS / CTN
U1231	6"	12	120
U1232	7"	12	120
U1233	8"	12	120



MASONRY TROWEL



HIGHLIGHTS

- Wooden handle
- Steel blade, easy to use
- Tempered ground and polished for perfect balance

PART NO	DESCRIPTION	PCS / PKT	PCS / CTN
U03046	6"	12	120
U03047	7"	12	120
U03048	8"	12	120

MASONRY TROWEL - HEAVY DUTY



HIGHLIGHTS

- Steel blade, easy to use
- Heavy Duty Application
- Tempered ground and polished for perfect balance

PART NO	DESCRIPTION	PCS / PKT	PCS / CTN
U03566	6"	12	120
U03567	7"	12	120
U03568	8"	12	120

MASONRY TROWEL - TPR HANDLE



HIGHLIGHTS

- Heavy duty stainless steel
- Tempered ground and polished for perfect balance
- TPR handle for better control and comfort

PART NO	DESCRIPTION	PCS / PKT	PCS / CTN
U1234	6"	12	60
U1235	7"	12	60
U1236	8"	12	60

MASONRY TROWEL - SQUARE WOODEN HANDLE



HIGHLIGHTS

- Heavy duty stainless steel square and trowel
- Wide pattern trowel carries more material and good for high productivity
- Natural wood handle

PART NO	DESCRIPTION	PCS / PKT	PCS / CTN
U1237	6"	12	60
U1238	7"	12	60

MASONRY TROWEL - FORGED

HIGHLIGHTS

- Steel blade, easy to use
- Tempered and polished for perfect balance
- Wooden handle
- Wide heel blade is popular for stone work

PART NO	DESCRIPTION	PCS / PKT	PCS / CTN
U0304-F6	6"	12	120
U0304-F7	7"	12	120
U0304-F8	8"	12	120



PLASTERING TROWEL - STEEL

Stainless steel finishing trowel features a precision ground edge that is "broke-in" and ready for use. Greater flexibility and durability reduces fatigue when finishing plaster.

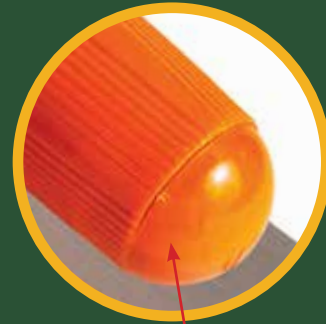

Light weight plastic grip handle for smoother use



Stainless steel blade with greater flexibility and durability

HIGHLIGHTS

- Stainless steel blade for textured and sculptured stone finishes used to create a dimensional smooth finish to interior wall and ceilings
- Plastic handle

PART NO	DESCRIPTION	PCS / PKT	PCS / CTN
U17001	12"	12	60

**PLASTERING TROWEL
STEEL - TEETH**



HIGHLIGHTS

- Plastic handle with square teeth
- Smooth finish for interior wall & Ceilings

PART NO	DESCRIPTION	PCS / PKT	PCS / CTN
U17002	12" (1/4 x 1/4) Teeth	12	60
U17003	12" (1/2 x 1/2) Teeth	12	60

**PLASTERING TROWEL
STEEL - ZIGZAG**



HIGHLIGHTS

- Plastic handle with zig zag teeth
- Smooth finish for interior wall & Ceilings

PART NO	DESCRIPTION	PCS / PKT	PCS / CTN
U17004	12"	12	60

PLASTERING TROWEL - STEEL



HIGHLIGHTS

- Wooden handle
- High - Strength aluminium mounting
- Smooth and finish for interior wall & ceilings

PART NO	DESCRIPTION	PCS / PKT	PCS / CTN
U04311	12"	12	60

PLASTERING TROWEL STEEL - TEETH



HIGHLIGHTS

- Big trowel point
- Wooden handle with square teeth
- Steel blade
- Designed for finishing and polishing for interior wall & ceilings

PART NO	DESCRIPTION	PCS / PKT	PCS / CTN
U04312	12" (1/2 x 1/2) Teeth	12	60
U04313	12" (1/4 x 1/4) Teeth	12	60

PLASTERING TROWEL STEEL - ZIGZAG



HIGHLIGHTS

- Wooden handle with zig zag teeth
- Smooth finish for interior wall & ceilings

PART NO	DESCRIPTION	PCS / PKT	PCS / CTN
U04314	12"	12	60

PLASTERING TROWEL - STEEL



HIGHLIGHTS

- Big trowel point
- Steel blade with wooden handle
- Designed for finishing and polishing for interior wall & ceilings

PART NO	DESCRIPTION	PCS / PKT	PCS / CTN
U0428	16"	12	60

PLASTERING TROWEL GREEN HANDLE - WOOD



HIGHLIGHTS

- Wooden handle (green) with stainless steel blade
- High - Strength aluminium mounting
- Smooth finish for interior wall & ceilings

PART NO	DESCRIPTION	PCS / PKT	PCS / CTN
U04315	280 x 130 MM	12	60

PLASTERING TROWEL GREEN HANDLE WOOD



HIGHLIGHTS

- Wooden handle (green) with stainless steel blade
- Smooth finish for interior wall & ceilings

PART NO	DESCRIPTION	PCS / PKT	PCS / CTN
U04316	480 x 130 MM	12	60

PVC FLOAT

HIGHLIGHTS

- PVC trowel
- Less weight & Smooth finish
- Suitable for Interior wall & ceilings

PART NO	DESCRIPTION	PCS / PKT	PCS / CTN
U120	14 cm x 28 cm	1	36 / 60



PAINT MIXER - HEAVY DUTY



HIGHLIGHTS

- Mixing blades
- Mixing effect top to bottom
- Suitable for thin light fluid material such as colours base sludges

PART NO	DESCRIPTION	PCS / PKT	PCS / CTN
UF09	W 80 X L 400	1	40
UF09	W 100 X L 600	1	20

PAINT MIXER - SUPER DUTY



HIGHLIGHTS

- Mixing blades
- Mixing effect bottom to top
- Sticky and Viscous materials

PART NO	DESCRIPTION	PCS / PKT	PCS / CTN
U4615	W 80 X L 400	1	40
U4616	W 100 X L 600	1	20



We provide Silicone / Caulking gun specifically designed sealant applicators for the professional or DIY enthusiast, this range of applicators which include manual and pneumatic are built to enable you to undertake the most demanding of jobs with confidence and control right where you need it?

High tension spring for long life

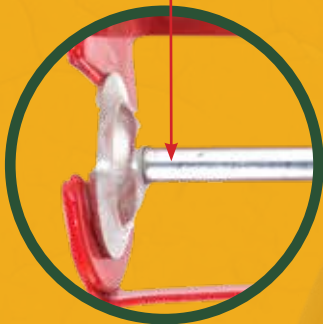

Steel rod for durability

SILICONE / CAULKING GUN - HEAVY DUTY

HIGHLIGHTS

- Heavy duty application
- Skelton frame
- Handle with plunger & release clip
- Suitable for all purpose

PART NO	PCS / PKT	PCS / CTN
UB08	1	24

SILICONE / CAULKING GUN - SUPER DUTY



HIGHLIGHTS

- Super duty application
- Rotating caulking silicon gun
- Skelton frame capacity 400 ml
- Handle with plunger & release clip
- Suitable for all purpose

PART NO	PCS / PKT	PCS / CTN
U4610	1	20

SILICONE / CAULKING GUN - LIGHT DUTY



HIGHLIGHTS

- Light duty application
- Skelton frame
- Handle with plunger & release clip
- Suitable for all purpose

PART NO	PCS / PKT	PCS / CTN
UB04	1	24

SAUSAGE GUN



HIGHLIGHTS

- Smooth rod and easy trigger action for easy dispensing
- Thump release helps prevents dripping
- Spring release plunger allows for quick loading

PART NO	PCS / PKT	PCS / CTN
UC13	1	24

WOOL PAD

HIGHLIGHTS

- For high gloss polish
- Perfect for Auto industries



PART NO	DESCRIPTION	PCS / PKT	PCS / CTN
U4800	7"	1	30

WOOL BONNET



HIGHLIGHTS

- For high gloss polish

PART NO	DESCRIPTION	PCS / PKT	PCS / CTN
U4801	7"	1	50

HAND BLOCK



HIGHLIGHTS

- The sanding block is made of high quality raw materials
- This can help the bottom surface endure pressure & keep flat, smooth & durable

PART NO	DESCRIPTION	PCS / PKT	PCS / CTN
U4802	70x198mm	1	-

RUBBER PAD



HIGHLIGHTS

- Used with pressure sensitive abrasive paper
- High quality Raw materials for Consistant sutable for Angle grinder and Polishing machine

PART NO	DESCRIPTION	PCS / PKT	PCS / CTN
U4810	4"	1	100
U4811	4.5"	1	100
U4812	5"	1	100
U4813	7"	1	100

SANDING PAD WITH EVA



HIGHLIGHTS

- Ideal for flat surface and fast Removal
- Great for general-purpose Sanding & Polishing
- Material ABS and suitable for Angle Grinder & Polishing Machine

PART NO	DESCRIPTION	PCS / PKT	PCS / CTN
U4816	4"	1	100
U4817	4.5"	1	100
U4818	5"	1	100
U4819	6"	1	100
U4820	7"	1	100

SANDING PAD WITHOUT EVA



HIGHLIGHTS

- Material ABS
- Suitable for angle grinder & Polishing Machine

PART NO	DESCRIPTION	PCS / PKT	PCS / CTN
U4821	4"	1	100
U4822	4.5"	1	100
U4823	5"	1	100
U4824	6"	1	100
U4825	7"	1	100

FLICKER / RUSH MACHINE - STAINLESS STEEL

HIGHLIGHTS

- Easy to handle & hand operated
- Very light weight
- No need of skilled mason
- No wastage of materials
- Stainless steel

PART NO	PCS / PKT	PCS / CTN
U4617	1	12



FLICKER / RUSH MACHINE



HIGHLIGHTS

- Easy to handle & hand operated
- Very light weight
- No need of skilled mason
- No wastage of materials

PART NO	PCS / PKT	PCS / CTN
116001	1	12

HAND WIRE BRUSH - WOOD



HIGHLIGHTS

- Wooden handle
- Seamless finish
- Resistance against corrosion
- Long lasting

PART NO	PCS / PKT	PCS / CTN
U42121	12	120

FLICKER / RUSH MACHINE BLADE



PART NO	PCS / PKT	PCS / CTN
116002	1	24

HAND WIRE BRUSH - PLASTIC



HIGHLIGHTS

- Ergonomic handle
- Curved face for hard to reach places
- Narrow brush allows access in to tight area slots
- Long lasting

PART NO	PCS / PKT	PCS / CTN
U42122	12	120



CLAW HAMMER

TPR / Fibreglass adds strength and durability. Ergonomic comfort grip features a ribbed surface and flared end to provide a firm grip and reduce slippage. Forged high carbon steel head for durability.

Ribbed surface and flared end to provide a firm grip



Forged high carbon steel head for durability

HIGHLIGHTS

- American type claw hammer
- Drop forged high Quality Steel
- Fiber glass/TPR handle with High Grip
- Polished Head

PART NO	DESCRIPTION	PCS / PKT	PCS / CTN
U7050	16 OZ	1	36

CLAW HAMMER HICKORY HANDLE - WISDOM



HIGHLIGHTS

- Drop Forged High Quality Steel
- Hickory handle
- Polished head

PART NO	DESCRIPTION	PCS / PKT	PCS / CTN
U7051	8 OZ	6	36
U7052	16 OZ	6	36
U7053	24 OZ	6	24

CLAW HAMMER FIBREGLASS HANDLE - WISDOM



HIGHLIGHTS

- Drop Forged High Quality Steel
- Fiberglass / TPR handle with high grip
- Polished head

PART NO	DESCRIPTION	PCS / PKT	PCS / CTN
U7054	8 OZ	6	48
U7055	16 OZ	6	36
U7056	24 OZ	6	24

CLAW /CARPENTER HAMMER



HIGHLIGHTS

- Induction hardened head, drop forged
- Wooden handle
- Selected Carbon
- Polished head

PART NO	DESCRIPTION	PCS / PKT	PCS / CTN
UH15016	16 OZ	6	36

CLAW /CARPENTER HAMMER - FIBER HANDLE



HIGHLIGHTS

- Induction hardened head, drop forged
- TPR handle with high grip
- Polished head

PART NO	DESCRIPTION	PCS / PKT	PCS / CTN
UH16008	08 OZ	6	48
UH16016	16 OZ	6	36
UH16024	24 OZ	6	24



MECHANICAL HAMMER HICKORY HANDLE - WISDOM



HIGHLIGHTS

- Drop Forged High Quality Steel
- Hickory handle
- Black Lacquer Polished Head

PART NO	DESCRIPTION	PCS / PKT	PCS / CTN
U7058	500G	6	36
U7059	1000G	4	12

MECHANICAL HAMMER FIBREGLASS HANDLE - WISDOM



HIGHLIGHTS

- Drop Forged High Quality Steel
- Fiberglass / TPR handle with high grip
- Black Lacquer Polished Head

PART NO	DESCRIPTION	PCS / PKT	PCS / CTN
U7063	500G	6	24
U7064	1000G	6	12

CHIPPING HAMMER - WOOD HANDLE



HIGHLIGHTS

- Induction hardened head, drop forged
- Wooden handle
- Polished head

PART NO	DESCRIPTION	PCS / PKT	PCS / CTN
UH21500	500 G	6	36

MECHANIC HAMMER - WOOD HANDLE



HIGHLIGHTS

- Induction hardened head, drop forged
- Wooden handle
- Polished head

PART NO	DESCRIPTION	PCS / PKT	PCS / CTN
UH23500	500 G	6	48
UH231000	1000 G	6	24

MECHANIC HAMMER - FIBER HANDLE



HIGHLIGHTS

- Induction hardened head, drop forged
- TPR handle with high grip
- Polished head

PART NO	DESCRIPTION	PCS / PKT	PCS / CTN
UH11001	300 G	6	60
UH11003	1000 G	6	24

CHIPPING HAMMER - FIBER HANDLE



HIGHLIGHTS

- Induction hardened head, drop forged
- TPR handle with high grip
- Polished head

PART NO	DESCRIPTION	PCS / PKT	PCS / CTN
UH10002	500 G	6	36

BALL PEIN HAMMER HICKORY HANDLE - WISDOM



HIGHLIGHTS

- Drop Forged High Quality Steel
- Hickory handle
- Polished head

PART NO	DESCRIPTION	PCS / PKT	PCS / CTN
U7068	1.5LB/24 OZ	6	24
U7069	2LB/32 OZ	6	12

BALL PEIN HAMMER - WOOD HANDLE



HIGHLIGHTS

- Induction hardened head, drop forged
- Wooden handle
- Polished head

PART NO	DESCRIPTION	PCS / PKT	PCS / CTN
UH2202	2 LB	6	24
UH2203	3 LB	6	12

BALL PEIN HAMMER FIBREGLASS HANDLE - WISDOM



HIGHLIGHTS

- Drop Forged High Quality Steel
- Fiberglass / TPR handle with high grip
- Polished head

PART NO	DESCRIPTION	PCS / PKT	PCS / CTN
U7074	1.5LB/24 OZ	6	24
U7075	2LB/32 OZ	6	12

BALL PEIN HAMMER - FIBER HANDLE



HIGHLIGHTS

- Induction hardened head, drop forged
- TPR handle with high grip
- Polished head

PART NO	DESCRIPTION	PCS / PKT	PCS / CTN
UH14003	2 LB	6	24
UH14004	3 LB	6	12



SLEDGE HAMMER - FIBER HANDLE

HIGHLIGHTS

- Induction hardened head, drop forged
- TPR handle with high grip
- Polished head

PART NO	DESCRIPTION	PCS / PKT	PCS / CTN
UH18002	2LB	6	24
UH18003	3LB	6	12
UH18004	4LB	6	12
UH18006	6LB	1	6
UH18008	8LB	1	4
UH18010	10LB	1	4
UH18012	12LB	1	4
UH18014	14LB	1	4



SLEDGE HAMMER - WOOD HANDLE

HIGHLIGHTS

- Induction hardened head, drop forged
- Wooden handle
- Forged carbon steel
- Polished head

PART NO	DESCRIPTION	PCS / PKT	PCS / CTN
UH17002	2LB	6	24
UH17003	3LB	6	12
UH17004	4LB	6	12
UH17006	6LB	1	6
UH17008	8LB	1	4
UH17010	10LB	1	4
UH17012	12LB	1	4
UH17014	14LB	1	4



RUBBER HAMMER - BLACK (WOOD HANDLE)



HIGHLIGHTS

- Rubber mallet black with wooden handle
- Heavy duty rubber head

PART NO	DESCRIPTION	PCS / PKT	PCS / CTN
UH19008	8 OZ	6	60
UH19012	12 OZ	6	48
UH19016	16 OZ	6	36
UH19024	24 OZ	6	24
UH19032	32 OZ	6	24

RUBBER HAMMER - BLACK (FIBER HANDLE)



HIGHLIGHTS

- Rubber mallet black with fibre handle
- Heavy duty rubber head

PART NO	DESCRIPTION	PCS / PKT	PCS / CTN
UH19308	8 OZ	6	60
UH19312	12 OZ	6	48
UH19316	16 OZ	6	36
UH19324	24 OZ	6	24
UH19332	32 OZ	6	24



RUBBER HAMMER - WHITE (WOOD HANDLE)



HIGHLIGHTS

- Rubber mallet white with wooden handle
- Heavy duty rubber head

PART NO	DESCRIPTION	PCS / PKT	PCS / CTN
UH19108	8 OZ	6	60
UH19112	12 OZ	6	48
UH19116	16 OZ	6	36
UH19124	24 OZ	6	24
UH19132	32 OZ	6	24

RUBBER HAMMER - WHITE (FIBRE HANDLE)



HIGHLIGHTS

- Rubber mallet white with fibre handle
- Heavy duty rubber head

PART NO	DESCRIPTION	PCS / PKT	PCS / CTN
UH19208	8 OZ	6	60
UH19212	12 OZ	6	48
UH19216	16 OZ	6	36
UH19224	24 OZ	6	24
UH19232	32 OZ	6	24

WRECKING BAR SUPER DUTY - WISDOM



HIGHLIGHTS

- Forged from hexagonal alloy steel
- Heat treated for extra strength and durability
- 60 degree gooseneck end and 30 degree prying end

PART NO	DESCRIPTION	PCS / PKT	PCS / CTN
U7040	18 "	6	12
U7041	24"	6	12
U7042	36"	4	8

**WRECKING BAR
SUPER DUTY EUROPEAN STYLE**

HIGHLIGHTS

- Forged from hexagonal alloy steel
- Heat treated for extra strength and durability
- 100 degree opening end and 30 degree prying end

PART NO	DESCRIPTION	PCS / PKT	PCS / CTN
U7045	18 "	6	12
U7046	24"	6	12
U7047	36"	3	6



BARBENDING KEY

HIGHLIGHTS

- One piece forged from round steel.
- Heat treated for extra strength and durability
- Precision forged size for proper bending

PART NO	DESCRIPTION	PCS / PKT	PCS / CTN
U7001	6 MM	1	16
U7002	8 MM	1	16
U7003	10 MM	1	12
U7004	12 MM	1	12
U7005	14 MM	1	9
U7006	16 MM	1	9
U7007	18 MM	1	9
U7008	20 MM	1	9
U7009	22 MM	1	9
U7010	24 MM	1	9
U7011	26 MM	1	6
U7012	28 MM	1	6
U7013	30 MM	1	6
U7014	32 MM	1	6



FLAT CHISEL SUPER DUTY - WISDOM



HIGHLIGHTS

- Forged from octagonal alloy steel.
- Heat treated for extra strength and durability
- Flat tip with ground cutting edge

PART NO	DESCRIPTION	PCS / PKT	PCS / CTN
U7031	8"	6	48
U7032	10"	6	48
U7033	12"	6	36

POINT CHISEL SUPER DUTY - WISDOM



HIGHLIGHTS

- Forged from octagonal alloy steel.
- Heat treated for extra strength and durability
- Pointed tip with ground cutting edge

PART NO	DESCRIPTION	PCS / PKT	PCS / CTN
U7035	8"	6	48
U7036	10"	6	48
U7037	12"	6	36

FLAT CHISEL SUPER DUTY WITH GRIP - WISDOM



HIGHLIGHTS

- Forged from octagonal alloy steel
- Heat treated for extra strength and durability
- Flat tip with double colour grip with TPR handle

PART NO	DESCRIPTION	PCS / PKT	PCS / CTN
U7021	8"	6	24
U7022	10"	6	24
U7023	12"	6	24

POINT CHISEL SUPER DUTY WITH GRIP - WISDOM



HIGHLIGHTS

- Forged from octagonal alloy steel.
- Heat treated for extra strength and durability
- Pointed tip with double color grip

PART NO	DESCRIPTION	PCS / PKT	PCS / CTN
U7027	8"	6	24
U7028	10"	6	24
U7029	12"	6	24



PIN PUNCH SET 6PCS



HIGHLIGHTS

- CRV Steel
- 2x115mm, 3x125mm, 4x150mm, 5x165mm, 6x180mm, 8x180mm

PART NO	DESCRIPTION	PCS / PKT	PKT / CTN
U1400	2-8 MM	6	36

PIN PUNCH



HIGHLIGHTS

- CRV Steel

PART NO	DESCRIPTION	PCS / PKT	PCS / CTN
U1402	2X10X150	10	50
U1403	3X10X150	10	50
U1404	4X10X150	10	50
U1405	5X10X150	10	50
U1406	6X10X150	10	50
U1407	8X10X150	10	50

PIN & CENTER PUNCH SET 6 PCS



HIGHLIGHTS

- CRV Steel
- 5x165mm, 6x180mm, 8x180mm, 3x125mm, 4x125mm, 4x125mm

PART NO	DESCRIPTION	PCS / PKT	PKT / CTN
U1401	-	6	36

CENTER PUNCH



HIGHLIGHTS

- CRV Steel

PART NO	DESCRIPTION	PCS / PKT	PCS / CTN
U1494	4X10X120	-	-
U1495	5X12X120	-	-
U1496	5X12X150	-	-

NO. 2 WOOD PLANE



HIGHLIGHTS

- Adjustable alloy steel blade, hardened & tempered with a fully polished finish
- Cast Iron body with a precision miled base
- Plane dimensions: 42mm blade(w) x175mm base L

PART NO	DESCRIPTION	PCS / PKT	PCS / CTN
U1485	42MM X 175MM	1	20

NO. 4 WOOD PLANE



HIGHLIGHTS

- Adjustable alloy steel blade, hardened & tempered with a fully polished finish
- Cast Iron body with a precision miled base
- Plane dimensions: 50mm blade(w) x254mm base

PART NO	DESCRIPTION	PCS / PKT	PCS / CTN
U1486	50MM X 254MM	1	10

NO. 5 WOOD PLANE



HIGHLIGHTS

- Adjustable alloy steel blade, hardened & tempered with a fully polished finish
- Cast Iron body with a precision miled base
- Plane dimensions: 50mm blade(w) x355mm base L

PART NO	DESCRIPTION	PCS / PKT	PCS / CTN
U1487	50MMX355MM	1	6

WOOD PLANE



HIGHLIGHTS

- Adjustable alloy steel blade, hardened & tempered with a fully polished finish
- Cast Iron body with a precision miled base
- Plane dimensions: 35mm blade(w) x135mm base L

PART NO	DESCRIPTION	PCS / PKT	PCS / CTN
U1488	35X135MM	10	40

WOOD PLANE



HIGHLIGHTS

- Adjustable alloy steel blade, hardened & tempered with a fully polished finish
- Cast Iron body with a precision miled base
- Plane dimensions: 44mm blade(w) x230mm base L

PART NO	DESCRIPTION	PCS / PKT	PCS / CTN
U1489	44X230MM	4	16

WOOD PLANE



HIGHLIGHTS

- Adjustable alloy steel blade, hardened & tempered with a fully polished finish
- Cast Iron body with a precision miled base
- Plane dimensions: 40mm blade(w) x160mm base L

PART NO	DESCRIPTION	PCS / PKT	PCS / CTN
U1490	40X160MM	8	40

CARPENTER CHISEL

A good chisel or nail set is as much about how it balances in the hand as the quality of the steel from which it's made. Uken's chisel pass this professional litmus test. They are shaped and balanced to provide great control.

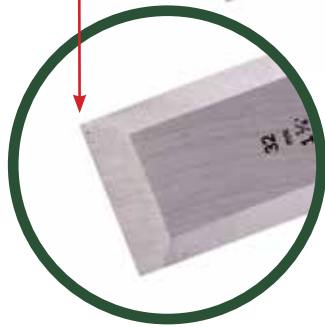

Din CrV

HIGHLIGHTS

- Induction hardened
- Cr-V . Steel
- Satin finish
- TPR handle with double colour sleeve for high grip

PART NO	DESCRIPTION	PCS / PKT	PCS / CTN
U4506	1/4"	6	36
U4510	3/8"	6	36
U4512	1/2"	6	36
U4516	5/8"	6	36
U4519	3/4"	6	36
U4522	7/8"	6	36
U4525	1"	6	36
U4532	1-1/4"	6	36
U4540	1-1/2"	6	36
U4550	2"	6	36

CARPENTER CHISEL SET- 5PCS

HIGHLIGHTS

- Drop forged Cr-v steel blade
- Heat treated for edge retention
- Blade edge honed
- Ergonomic grip handle - TPR handle



Din CrV

PART NO	DESCRIPTION	PCS / PKT	PCS / CTN
U4551	5PCS (1/4", 3/8", 1/2", 3/4", 1")	4	16



SCREW DRIVER - FLAT

Comfort, quality and versatility are the three attributes we engineer into our screwdriver line. The materials and construction are of the highest quality to resist corrosion, chipping and breaking.

HIGHLIGHTS

- The blade is Cr-V Steel
- Fully hardened and tempered
- Magnetized Tip
- Satin finish
- TPR Handle for high grip

PART NO	DESCRIPTION	PCS / PKT	PCS / CTN
U6020	3 X 75 MM	12	240
U6021	3 X 100 MM	12	240
U6022	4 X 100 MM	12	240
U6023	4 X 125 MM	12	240
U6024	5 X 150 MM	12	240
U6025	6 X 100 MM	12	120
U6026	6 X 150 MM	12	120
U6027	6 X 200 MM	12	120
U6028	6 X 250 MM	12	120
U6029	6 X 300 MM	12	120
U6030	6 X 38MM	12	240



Rubber grip with thumb indents makes prying easy

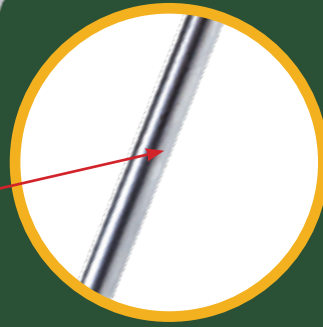

Shatter-resistant bar withstands heavy loads for striking and prying

SCREW DRIVER - STAR



HIGHLIGHTS

- The blade is Cr-V Steel
- Fully hardened and tempered
- Magnetized Tip
- Satin finish
- TPR Handle for high grip

PART NO	DESCRIPTION	PCS / PKT	PCS / CTN
U6050	PH0 X 75 MM	12	240
U6051	PH0 X 100 MM	12	240
U6052	PH1 (4MM) X 100 MM	12	240
U6053	PH1 (4MM) X 125 MM	12	240
U6054	PH1 X 150 MM	12	240
U6055	PH2 X 100 MM	12	120
U6056	PH2 X 125 MM	12	120
U6057	PH2 X 150 MM	12	120
U6058	PH2 X 200 MM	12	120
U6059	PH2 X 250 MM	12	120
U6060	PH2 X 300 MM	12	120
U6061	PH2 X 38 MM	12	240



SCREW DRIVER SET - 7 PCS

HIGHLIGHTS

- The blade is Cr-V Steel
- Fully hardened & tempered
- Magnetized Tip, Satin finish
- TPR handle for high grip

PART NO	DESCRIPTION	PCS / PKT	PCS / CTN
U6000	4 PCS SLOTTED: ⊖ 8X150 MM, 6X125 MM, 5X150 MM, 5X75 MM 3 PCS PHILLIPS: ⊕ PH2 X 100 MM, PH1X75 MM, PH0X 75 MM	6	24
U6001	7 PCS PHILLIPS: ⊕ 8X150 MM, 3X75 MM, 6X75 MM, 5X100 MM, 5X150 MM, 6X150 MM	6	24
U6002	4 PCS SLOTTED: ⊖ 8X150 MM, 3X75 MM, 6X75 MM, 5X100 MM, 5X150 MM, 6X150 MM	6	24



SCREW DRIVER SET - 7 PCS

HIGHLIGHTS

- Chrome vanadium blade
- Magnetized tip
- Double injected soft handle
- Hardened and tempered blade

PART NO	DESCRIPTION	PCS / PKT	PCS / CTN
U6009	4 PCS SLOTTED: ⊖ 8X150 MM, 6X125 MM, 5X150 MM, 5X75 MM 3 PCS PHILLIPS: ⊕ PH2 X 100 MM, PH1X75 MM, PH0X 75 MM	6	24
U6010	7 PCS PHILLIPS: ⊕ 3X150 MM, PH2X150 MM, PH1X150 MM, PH1X100 MM, PH2X75 MM, PH0X75 MM, PH2X38 MM	6	24
U6011	7 PCS SLOTTED: ⊖ 8X150 MM, 6X150 MM, 5X150 MM, 5X100 MM, 6X75 MM, 3X75 MM, 6X38 MM	6	24



PRECISION SCREW DRIVER SET - 6 PCS

HIGHLIGHTS

- Cr-V Steel
- TPR handle for high grip
- Chrome plated
- Black tips

PART NO	DESCRIPTION	PCS / PKT	PCS / CTN
U6007	⊖ 2 PCS SLOTTED: 2.5X50 MM, 3.0 X 50 MM ⊕ 2 PCS PHILLIPS: PH00X50 MM, PH0X50 MM ⊛ 2 PS TORX: T5X50 MM, T6 X 50 MM	6	36



RATCHET SCREW DRIVER SET 8 PCS



HIGHLIGHTS

- Ergonomically designed
- TPR Handles for better control & comfort
- Fully magnetized Cr-V blade
- Made by high grade special alloy steel

PART NO	DESCRIPTION	PCS / PKT	PCS / CTN
U6006	1 PC RATCHET SCREWDRIVER 1 PC MAGNETIC HOLDER 6 PCS BITS (6.35 X 25 MM) ⊖ 4MM,5MM,6MM ⊕ PH1, PH2, PH3	6	48

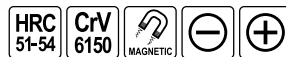

RATCHET SCREW DRIVER SET



HIGHLIGHTS

- Cr-V Steel
- TPR handle for high grip
- Chrome plated

PART NO	DESCRIPTION	PCS / PKT	PCS / CTN
U6008	1 PC PRECISION RATCHET SCREWDRIVER 1 PC 100 MM PRECISION BITS DRIVER 20 PC PRECISION BITS (4 X 28 MM) ⊖ 2.0 MM, 2.5 MM, 3.0 MM, 3.5 MM, 4.0 MM ⊕ PH000, PH000, PH00, PH0, PH1 ⊗ T4, T5, T6, T7, T8 ○ H0.7, H0.9, H1.3, H1.5, H2.0	8	24



NUT DRIVER



HIGHLIGHTS

- Ergonomically designed
- Made high grade special alloy steel
- TPR handle allows for better torque and comfort
- Chrome plated shaft helps prevent corrosion

PART NO	DESCRIPTION	PCS / PKT	PCS / CTN
U5941	4 MM	6	72
U5942	5 MM	6	72
U5943	6 MM	6	72
U5944	7 MM	6	72
U5945	8 MM	6	72
U5946	9 MM	6	72
U5947	10 MM	6	72
U5948	11 MM	6	72
U5949	12 MM	6	72
U5950	13 MM	6	72

SCREW BIT 10 PCS/SET



HIGHLIGHTS

- S2 Material
- PH2

PART NO	DESCRIPTION	SET/ PKT	SET/ CTN
U1571	PH2X25MM	6	72
U1572	PH2X50MM	6	72

SCREW BIT DOUBLE END 10 PCS/SET



HIGHLIGHTS

- S2 Material
- PH2

PART NO	DESCRIPTION	SET/ PKT	SET/ CTN
U1575	PH2X50MM	6	72
U1576	PH2X65MM	6	72
U1577	PH2X100MM	6	36
U1578	PH2X150MM	6	36



BIT HOLDER 5PCS/SET

HIGHLIGHTS

- S2 Material
- PH2

PART NO	DESCRIPTION	SET/ PKT	SET/ CTN
U1565	60MM	12	72

NUT SETTER

HIGHLIGHTS

- S2 Material
- With Magnet



PART NO	DESCRIPTION	PCS / SET	SET / CTN
U1596	3/8"X65MM	5	72
U1592	8MMX65MM	5	72
U1593	10MMX65MM	5	72
U1594	13MMX65MM	3	72

SCREW BIT DOUBLE END IMPACT 10PCS/SET



HIGHLIGHTS

- S2 Material
- Heavy duty Impact bit

PART NO	DESCRIPTION	SET/ PKT	SET/ CTN
U1581	PH2 X 50MM	6	72
U1582	PH2 X 65MM	6	72

SINGLE - POLE VOLTAGE TESTER - VDE



HIGHLIGHTS

- Full insulated blade ensure shock proof working.
- Distinet glow of neon lamp identifies line

PART NO	DESCRIPTION	PCS / PKT	PCS / CTN
U6005	38 x 27.5 x 27	20	200

TESTERS



HIGHLIGHTS

- Ergonomically designed
- High blade and cellulose acetate plastic handle
- Full insulated blade ensure shock proof working
- Distinet glow of neon lamp identifies line

PART NO	DESCRIPTION	PCS / PKT	PCS / CTN
U6016	135 MM	20PCS/BOX	500
U6017	210 MM	20PCS/BOX	500

POCKET TYPE SCREW DRIVERS



HIGHLIGHTS

- Easy to carry
- 2 Side screw driver (star & flat)
- Cr-V steel blade
- TPR body cover
- Magnetized tip

PART NO	DESCRIPTION	PCS / PKT	PCS / CTN
U6004	2 PC DOUBLE ENDED CRV BITS ⊖ 3 MM, 4 MM ⊕ PH0, PH1	20	200

SCREW DRIVER SET VDE

HIGHLIGHTS

- For the use in terminal blocks, control cabinets, switches, relays, socket etc
- Insulated / specialized security tool

PART NO	DESCRIPTION	PCS / PKT	PCS / CTN
U6015	33 x 29.8 x 60.5 4 PCS SLOTTED: ⊖ 1.2X6.5X150 mm, 1.0X5.5X125mm, 0.8X4.0X100 mm, 0.4X2.5X75 mm 2 PCS POZIDRIV: ⊕ PZ2X100mm, PH1X80mm 1 PCS SINGLE - POLE VOLTAGE TESTER	4	24



RATCHET HANDLE WITH QUICK RELEASE BUTTON

Din CrV



HIGHLIGHTS

- Hexagonal & biexagonal jaws
- Cr-V Steel
- Mirror finish, fully hardened & tempered
- TPR Handle for high grip

PART NO	DESCRIPTION	PCS / PKT	PCS / CTN
U5910	1/4" DR	6	48
U5911	3/8" DR	6	24
U5912	1/2" DR	6	24

RATCHET HANDLE POLISHED

Din CrV



HIGHLIGHTS

- Hexagonal & Biexagonal jaws
- Cr-V Steel
- Mirror finish
- Fully hardened & tempered

PART NO	DESCRIPTION	PCS / PKT	PCS / CTN
U5913	1/2" DR	6	24

RATCHET HANDLE POLISHED ANGLE TYPE



HIGHLIGHTS

- 1/4", 3/8" 1/2" Drive reversible ratchet
- 72 Ratchet with full polished
- Angle design drive

PART NO	DESCRIPTION	PCS / PKT	PCS / CTN
U5914	1/4"	10	100
U5915	3/8"	5	40
U5916	1/2"	5	30

RACHET HANDLE - 3/4"

Din CrV



HIGHLIGHTS

- Hexagonal & Biexagonal jaws
- Cr-V Steel
- Mirror finish
- Fully hardened & tempered

PART NO	DESCRIPTION	PCS / PKT	PCS / CTN
U5965	3/4"	1	-

ADAPTOR

Din
CrV



HIGHLIGHTS

- Cr-V Steel
- Mirror finish
- Chrome plated

PART NO	DESCRIPTION	PCS / PKT	PCS / CTN
U5931	1/4" M X 3/8" F	25	300
U5932	3/8" M X 1/4" F	32	384
U5933	1/2" M X 3/8" F	28	326
U5934	3/8" M X 1/2" F	18	206
U5935	3/4" M X 1/2" F	12	144
U5936	1/2" M X 3/4" F	4	48

IMPACT ADAPTOR

Din
CrV



HIGHLIGHTS

- Cr-V Steel
- Black finish
- Hardened and tempered

PART NO	DESCRIPTION	PCS / PKT	PCS / CTN
U5740	1/4" F X 3/8" M	40	200
U5741	3/8" F X 1/2" M	30	300
U5742	1/2" F X 3/4" M	10	100
U5743	1" F X 3/4" M	2	20
U5744	3/4" F X 1" M	4	40
U5745	3/4" F X 1/2" M	4	40
U5746	3/8" F X 1/4" M	30	300
U5747	1/2" F X 3/8" M	24	192

1/4" DR 6PT SOCKETS



HIGHLIGHTS

- Cr-V Steel
- Mirror finish
- Chrome plated

PART NO	DESCRIPTION	PCS / PKT	PCS / CTN
U1504	4MM	1	-
U15045	4.5MM	1	-
U1505	5MM	1	-
U15055	5.5MM	1	-
U1506	6MM	1	-
U1507	7MM	1	-
U1508	8MM	1	-
U1509	9MM	1	-
U1510	10MM	1	-
U1511	11MM	1	-
U1512	12MM	1	-

3/8" DR 6PT SOCKETS

HIGHLIGHTS

- Cr-V Steel
- Mirror finish
- Chrome plated

PART NO	DESCRIPTION	PCS / PKT	PCS / CTN
U3806	6MM	1	-
U3807	7MM	1	-
U3808	8MM	1	-
U3809	9MM	1	-
U3810	10MM	1	-
U3811	11MM	1	-
U3812	12MM	1	-
U3813	13MM	1	-
U3814	14MM	1	-
U3815	15MM	1	-
U3817	17MM	1	-
U3819	19MM	1	-
U3821	21MM	1	-
U3822	22MM	1	-



1/2" DR 6PT SOCKETS

1/2"

Din

CrV



HIGHLIGHTS

- Cr-V Steel
- Mirror finish
- Chrome plated

PART NO	DESCRIPTION	PCS / PKT	PCS / CTN
U5508	8 MM	20	200
U5509	9 MM	20	200
U5510	10 MM	20	200
U5511	11 MM	20	200
U5512	12 MM	20	200
U5513	13 MM	20	200
U5514	14 MM	20	200
U5515	15 MM	20	200
U5516	16 MM	20	200
U5517	17 MM	20	200
U5518	18 MM	20	200
U5519	19 MM	20	200
U5520	20 MM	20	200
U5521	21 MM	20	200
U5522	22 MM	20	200
U5523	23 MM	20	200
U5524	24 MM	20	200
U5525	25 MM	20	200
U5526	26 MM	20	200
U5527	27 MM	10	100
U5528	28 MM	10	100
U5529	29 MM	10	100
U5530	30 MM	10	100
U5531	31 MM	10	100
U5532	32 MM	10	100

1/2" DR 12PT STANDARD SOCKETS

1/2"

Din

CrV



HIGHLIGHTS

- Cr-V Steel
- Mirror finish
- Chrome plated

PART NO	DESCRIPTION	PCS / PKT	PCS / CTN
U5608	8 MM	20	200
U5609	9 MM	20	200
U5610	10 MM	20	200
U5611	11 MM	20	200
U5612	12 MM	20	200
U5613	13 MM	20	200
U5614	14 MM	20	200
U5615	15 MM	20	200
U5616	16 MM	20	200
U5617	17 MM	20	200
U5618	18 MM	20	200
U5619	19 MM	20	200
U5620	20 MM	20	200
U5621	21 MM	20	200
U5622	22 MM	20	200
U5623	23 MM	20	200
U5624	24 MM	20	200
U5625	25 MM	20	200
U5626	26 MM	20	200
U5627	27 MM	10	100
U5628	28 MM	10	100
U5629	29 MM	10	100
U5630	30 MM	10	100
U5631	31 MM	10	100
U5632	32 MM	10	100



1/2" DR 6PT DEEP SOCKETS

HIGHLIGHTS

- Cr-V Steel
- Mirror finish
- Chrome plated

1/2"

Din

CrV



PART NO	DESCRIPTION	PCS / PKT	PCS / CTN
U5558	8 MM	20	200
U5559	9 MM	20	200
U5560	10 MM	20	200
U5561	11 MM	20	200
U5562	12 MM	20	200
U5563	13 MM	20	200
U5564	14 MM	20	200
U5565	15 MM	20	200
U5566	16 MM	20	200
U5567	17 MM	20	200
U5568	18 MM	20	200
U5569	19 MM	20	200
U5570	20 MM	20	200
U5571	21 MM	20	200
U5572	22 MM	20	200
U5573	23 MM	20	200
U5574	24 MM	20	200
U5577	27 MM	10	100
U5580	30 MM	10	50
U5582	32 MM	10	50

3/4" DR 6PT SOCKETS



HIGHLIGHTS

- Cr-V Steel
- Mirror finish
- Chrome plated

PART NO	DESCRIPTION	PCS / PKT	PCS / CTN
U3419	19 MM	1	-
U3421	21 MM	1	-
U3422	22 MM	1	-
U3423	23 MM	1	-
U3424	24 MM	1	-
U3426	26 MM	1	-
U3427	27 MM	1	-
U3429	29 MM	1	-
U3430	30 MM	1	-
U3432	32 MM	1	-
U3435	35 MM	1	-
U3436	36 MM	1	-
U3438	38 MM	1	-
U3441	41 MM	1	-
U3446	46 MM	1	-
U3450	50 MM	1	-



1/2" DR 6PT STANDARD IMPACT SOCKETS

1/2"

Din

CrV



HIGHLIGHTS

- Fully hardened & tempered
- Cr-V Steel
- Available in different sizes

PART NO	DESCRIPTION	PCS / PKT	PCS / CTN
U5708	8 MM	20	200
U5709	9 MM	20	200
U5710	10 MM	20	200
U5711	11 MM	20	200
U5712	12 MM	20	200
U5713	13 MM	20	200
U5714	14 MM	20	200
U5715	15 MM	20	200
U5716	16 MM	20	200
U5717	17 MM	20	200
U5718	18 MM	20	200
U5719	19 MM	20	200
U5720	20 MM	20	200
U5721	21 MM	20	200
U5722	22 MM	20	200
U5723	23 MM	20	200
U5724	24 MM	20	200
U5725	25 MM	10	100
U5726	26 MM	10	100
U5727	27 MM	10	100
U5728	28 MM	10	100
U5729	29 MM	10	100
U5730	30 MM	10	100
U5731	31 MM	10	100
U5732	32 MM	10	100

PART NO	DESCRIPTION	PCS / PKT	PCS / CTN
U5758	8 MM	10	100
U5759	9 MM	10	100
U5760	10 MM	10	100
U5761	11 MM	10	100
U5762	12 MM	10	100
U5763	13 MM	10	100
U5764	14 MM	10	100
U5765	15 MM	10	100
U5766	16 MM	10	100
U5767	17 MM	10	100
U5768	18 MM	10	100
U5769	19 MM	10	50
U5770	20 MM	10	50
U5771	21 MM	10	50
U5772	22 MM	10	50
U5773	23 MM	10	50
U5774	24 MM	10	50
U5775	25 MM	10	50
U5776	26 MM	10	58
U5777	27 MM	8	40
U5778	28 MM	8	48
U5779	29 MM	8	48
U5780	30 MM	8	40
U5781	31 MM	8	48
U5782	32 MM	8	48

1/2" DR 6PT DEEP IMPACT SOCKETS

1/2"

Din

CrV



HIGHLIGHTS

- Fully hardened & Tempered
- Cr-V Steel
- Available in different sizes

1/4"

Din

CrV



3/8"

Din

CrV



1/2"

Din

CrV



1/2"

Din

CrV



3/4"

Din

CrV

Heavy Duty



SOCKET SET

HIGHLIGHTS

- Fully hardened & tempered
- Cr-V steel
- Mirror finish
- TPR handle for high grip

PART NO	DESCRIPTION	PCS / PKT	PCS / CTN
---------	-------------	-----------	-----------

U5970 16 PCS (6 MM) 1/4" DR 1 4

11pcs 1/4" Sockets:4, 4.5, 5, 5.5, 6, 7, 8, 9, 10, 11, 12mm
 1pc 1/4" Extension bar 4"
 1pc 1/4" Spinner handle 6"
 1pc 1/4" Sliding t bar 115mL
 1pc 1/4" Universal joint
 1pc 1/4" Ratchet

PART NO	DESCRIPTION	PCS / PKT	PCS / CTN
---------	-------------	-----------	-----------

U5980 19 PCS 3/8" DR 1 4

14pcs 3/8"sockets:6, 7, 8, 9, 10, 11, 12, 13, 14, 15, 17, 19, 21, 22mm
 1pc 3/8" Ratchet handle
 1pc 3/8" Extension bar 6"
 1pc 3/8" Extension bar 12"
 1pc 3/8" Universal joint
 1pc 3/8" Flexible handle

PART NO	DESCRIPTION	PCS / PKT	PCS / CTN
---------	-------------	-----------	-----------

U5900 (10 MM) 1/2" DR - 25PCS 6 PT 1 4

Socket - 10/11/12/13/14/15/16/17/18/19/20/21/22/23/24/27/30/32
 Spark plug, Sliding T Handle, Extension bar 10", Extension bar 5",
 Universal joint, Ratchet handle & Adapter

PART NO	DESCRIPTION	PCS / PKT	PCS / CTN
---------	-------------	-----------	-----------

U5901 (10 MM) 1/2" DR - 25PCS 12 PT 1 4

Socket - 10/11/12/13/14/15/16/17/18/19/20/21/22/23/24/27/30/32
 Spark plug, Sliding T Handle, Extension bar 10", Extension bar 5",
 Universal joint, Ratchet handle & Adapter

DRIVE SOCKET SET - 3/4" DR - 21 PCS

HIGHLIGHTS

- Fully hardened & tempered
- Cr-V steel
- Mirror finish
- TPR handle for high grip

PART NO	DESCRIPTION	PCS / PKT	PCS / CTN
---------	-------------	-----------	-----------

U5960 3/4" DR - 21PCS 1 4

16 Pcs Socket - 19/21/22/23/24/26/27/29/30/32/35/36/
 38/41/46/50 MM
 3 Pcs Extension Bar: 100 MM, 200 MM, 400 MM
 1 Pcs Sliding Bar 450 MM
 1 Pcs Ratchet

STUD EXTRACTOR KIT - 4 PCS



HIGHLIGHTS

- Cr-V Steel
- Use 1/2" square driver accessory or 21 mm external ex drive
- Mirror finish
- Chrome plated
- For studs simply place extractor over and turn either clockwise or anticlockwise

PART NO	DESCRIPTION	PCS / PKT	PCS / CTN
U5905	6 MM, 8 MM, 10 MM, 12 MM	1	20

BITS SET - 13 PCS (TORX)



HIGHLIGHTS

- Cr-V Steel
- Mirror finish
- Chrome plated

PART NO	DESCRIPTION	PCS / PKT	PCS / CTN
U1570	6 Pcs - 30 MM Length: T30, 40, 45, 55, 60 6 Pcs - 75 MM Length: T30, 40, 45, 55, 60 1 Pcs - 1/2" Drive Bits Holder 10 MM	1	10

1/2" DR IMPACT BITS SOCKET - 8 PCS (HEX)

HIGHLIGHTS

- Cr-V Steel
- Black finish
- Chrome plated



PART NO	DESCRIPTION	PCS / PKT	PCS / CTN
U1520	HEX5, 6, 8, 10, 12, 14, 17, 19	1	10

1/2" DR IMPACT BITS SOCKET - 9 PCS (TORX)

HIGHLIGHTS

- Cr-V Steel
- Black finish
- Chrome plated



PART NO	DESCRIPTION	PCS / PKT	PCS / CTN
U1530	TORX T20, 25, 30, 40, 45, 50, 55, 60, 70	1	10



1/2" DR IMPACT BITS SOCKETS RIBI - 9 PCS

HIGHLIGHTS

- Cr-V Steel
- Black finish
- Chrome plated

PART NO	DESCRIPTION	PCS / PKT	PCS / CTN
U1540	MP5, 6, 7, 8, 9, 10, 12, 13, 14	1	10



1/2" DR IMPACT BITS SOCKETS SPLINE - 9 PCS

HIGHLIGHTS

- Cr-V Steel
- Black finish
- Chrome plated

PART NO	DESCRIPTION	PCS / PKT	PCS / CTN
U1550	M 4,5, 6, 8, 10, 12, 14, 16	1	10



L TYPE WRENCH - 3/4" (DR)

HIGHLIGHTS

- Cr-V Steel
- Mirror finish
- Chrome plated

PART NO	DESCRIPTION	PCS / PKT	PCS / CTN
U5966	450 MM	2	8



EXTENSION BAR WOBBLE TYPE

HIGHLIGHTS

- Cr-V Steel
- Mirror finish
- Chrome plated

PART NO	DESCRIPTION	PCS / PKT	PCS / CTN
U5939	125 MM	5	50
U5940	250 MM	5	50



EXTENSION BAR



Din CrV

HIGHLIGHTS

- Cr-V Steel
- Mirror finish
- Chrome plated

PART NO	DESCRIPTION	DRIVE	PCS / PKT	PCS / CTN
U5971	4"	1/4"	1	-
U5981	6"	3/8"	1	-
U5982	10"	3/8"	1	-
U5920	5"	1/2"	1	-
U5921	10"	1/2"	1	-
U5961	4"	3/4"	1	-
U5963	8"	3/4"	1	-
U5962	16"	3/4"	1	-

FLEXIBLE T WRENCH - SHORT SOCKET

1/2" Din CrV



HIGHLIGHTS

- Cr-V Steel
- Mirror finish
- Chrome plated

PART NO	DESCRIPTION	PCS / PKT	PCS / CTN
U5550	10 MM	5	20
U5551	11 MM	5	20
U5552	12 MM	5	20
U5553	13 MM	5	20
U5554	14 MM	5	20
U5555	15 MM	5	20
U5556	17 MM	5	20
U5557	19 MM	5	20

FLEXIBLE T WRENCH - DEEP SOCKET

1/2" Din CrV

HIGHLIGHTS

- Cr-V Steel
- Mirror finish
- Chrome plated



PART NO	DESCRIPTION	PCS / PKT	PCS / CTN
U5540	8 MM	5	20
U5541	9 MM	5	20
U5542	10 MM	5	20
U5543	12 MM	5	20
U5544	14 MM	5	20
U5545	16 MM	5	20

FLEXIBLE HANDLE - 1/2" DR

HIGHLIGHTS

- Cr-V Steel
- Mirror finish
- Chrome plated

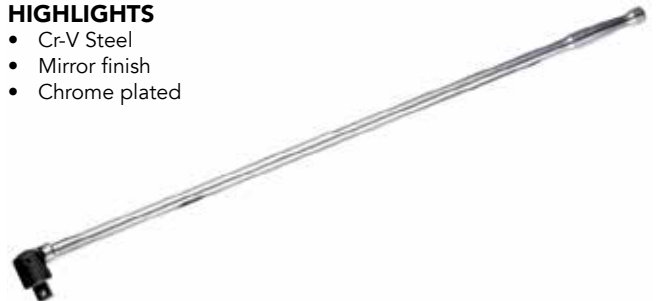

PART NO	DESCRIPTION	PCS / PKT	PCS / CTN
U5968	24"	2	8

FLEXIBLE HANDLE - 3/4" DR

HIGHLIGHTS

- Cr-V Steel
- Mirror finish
- Chrome plated



PART NO	DESCRIPTION	PCS / PKT	PCS / CTN
U5967	39"	2	8

SLIDING BAR

Din **CrV**



HIGHLIGHTS

- Cr-V Steel
- Mirror finish
- Chrome plated

PART NO	DESCRIPTION	DRIVE	PCS / PKT	PCS / CTN
U5973	115 MM	1/4"	1	-
U5923	250 MM	1/2"	1	-
U5964	450 MM	3/4"	1	-

UNIVERSAL JOINT

Din **CrV**



HIGHLIGHTS

- Cr-V Steel
- Pivots on two axis's along with 360° of rotation
- Mirror finish
- Chrome plated
- Expand to various angle

PART NO	DRIVE	PCS / PKT	PCS / CTN
U5974	1/4"	1	-
U5983	3/8"	1	-
U5922	1/2"	1	-

SPINNER HANDLE

Din **CrV**



HIGHLIGHTS

- Ergonomically designed
- Made high grade special alloy steel
- TPR handle allows for better torque and comfort
- Chrome plated shaft helps prevent corrosion

PART NO	DESCRIPTION	DRIVE	PCS / PKT	PCS / CTN
U5972	6 MM	1/4"	1	-

COMBINATION GEAR WRENCH



HIGHLIGHTS

- Duly hardened & tempered
- Cr-V Steel, drop forged
- Satin finish

PART NO	DESCRIPTION	PCS / PKT	PCS / CTN
U9506	6 MM	10	300
U9507	7 MM	10	300
U9508	8 MM	10	300
U9509	9 MM	10	300
U9510	10 MM	10	300
U9511	11 MM	10	300
U9512	12 MM	10	300
U9513	13 MM	10	150
U9514	14 MM	5	150
U9515	15 MM	5	150
U9516	16 MM	5	100
U9517	17 MM	5	100
U9518	18 MM	5	100
U9519	19 MM	5	100
U9520	20 MM	5	100
U9521	21 MM	5	50
U9522	22 MM	5	50
U9523	23 MM	5	50
U9524	24 MM	5	50
U9525	25 MM	5	50
U9527	27 MM	5	40/50
U9530	30 MM	3	30
U9532	32 MM	3	30

COMBINATION SPANNERS SET

HIGHLIGHTS

- Duly hardened & tempered
- Cr-V Steel, drop forged
- Matte finish & head polished



PART NO	DESCRIPTION	PCS / PKT	PCS / CTN
U9600	8PCS/6-22	1	20
U9601	10PCS8-24	1	20
U9602	12PCS6-32	1	6
U9603	24PCS/8-32	1	4

COMBINATION SPANNERS



HIGHLIGHTS

- Duly hardened & tempered
- Cr-V Steel, drop forged
- Satin finish
- Din standard 3113

PART NO	DESCRIPTION	PCS / PKT	PCS / CTN
U9606	6 MM	10	500
U9607	7 MM	10	500
U9608	8 MM	10	500
U9609	9 MM	10	500
U9610	10 MM	10	500
U9611	11 MM	10	500
U9612	12 MM	10	250
U9613	13 MM	10	250
U9614	14 MM	5	200
U9615	15 MM	5	200
U9616	16 MM	5	200
U9617	17 MM	5	100
U9618	18 MM	5	100
U9619	19 MM	5	100
U9620	20 MM	5	100
U9621	21 MM	5	100
U9622	22 MM	5	100
U9623	23 MM	5	100
U9624	24 MM	5	100
U9625	25 MM	5	100
U9626	26 MM	5	50
U9627	27 MM	5	50
U9628	28 MM	5	50
U9630	30 MM	5	50
U9632	32 MM	5	50
U9633	33 MM	5	50
U9635	35 MM	5	20
U9636	36 MM	5	20
U9638	38 MM	5	20
U9641	41 MM	5	20
U9642	42 MM	5	20
U9644	44 MM	5	20
U9646	46 MM	5	20
U9650	50 MM	5	20
U9655	55 MM	1	5
U9660	60 MM	1	5
U9665	65 MM	1	5

DOUBLE OFFSET RING SPANNER

HIGHLIGHTS

- Duly hardened & tempered
- Cr-V Steel, drop forged
- Satin finish

Din CrV



PART NO	DESCRIPTION	PCS / PKT	PCS / CTN
U9706	6 X 7	10	500
U9708	8 X 9	10	500
U9710	10 X 11	10	200
U9712	12 X 13	10	200
U9714	14 X 15	5	100
U9716	16 X 17	5	100
U9718	18 X 19	5	100
U9720	20 X 22	5	100
U9721	21 X 23	5	50
U9722	22 X 24	5	50
U9724	24 X 26	5	50
U9725	25 X 28	5	50
U9727	27 X 30	5	50
U9730	30 X 32	5	50
U9732	32 X 34	5	20
U9733	32 X 36	5	20
U9734	34 X 36	5	20
U9736	36 X 41	5	20
U9741	41 X 46	5	20
U9746	46 X 50	5	20
U9750	50 X 55	5	20
U9755	55 X 60	5	20

RING SPANNERS / DOUBLE RING WRENCH SET

HIGHLIGHTS

- Duly hardened & tempered
- Cr-V Steel
- Matte finish & head polished

Din CrV



PART NO	DESCRIPTION	SET / PKT	SET / CTN
U9700	8PCS/6-22	1	10
U9701	12PCS/6-32	1	4

DOUBLE OPEN END SPANNER / WRENCH SET

HIGHLIGHTS

- Duly hardened & tempered
- Cr-V Steel
- Satin finish

Din CrV



PART NO	DESCRIPTION	SET / PKT	SET / CTN
U9800	8PCS/6-22	1	20
U9801	12PCS/6-32	1	6

DOUBLE OPEN END SPANNER / WRENCH

HIGHLIGHTS

- Duly hardened & tempered
- Cr-V Steel, drop forged
- Satin finish



Din **CrV**

PART NO	DESCRIPTION	PCS / PKT	PCS / CTN
U9806	6×7	10	500
U9808	8×9	10	500
U9810	10 ×11	10	300
U9812	12 X 13	10	200
U9814	14 X 15	10	200
U9816	16 X 17	10	200
U9818	18 X 19	5	100
U9820	20 X 22	5	100
U9821	21 X 23	5	100
U9822	22 X 24	5	100
U9824	24 X 26	5	50
U9825	25 X 28	5	50
U9827	27 X 30	5	50
U9830	30 X 32	5	50
U9832	32 X 34	5	20
U9833	32 X 36	5	20
U9834	34 X 36	5	20
U9836	36 X 41	5	20
U9841	41 X 46	5	20
U9846	46 X 50	5	20
U9850	50 X 55	5	20
U9855	55 X 60	5	20
U9870	70 X 75	5	20
U9875	75 X 80	5	20

ADJUSTABLE WRENCH

HIGHLIGHTS

- Drop forged, hardened jaws
- Bright chrome
- Cr-V Steel



Din **CrV**

PART NO	DESCRIPTION	PCS / PKT	PCS / CTN
U41150	6"	6	120
U41200	8"	6	90
U41250	10"	6	60
U41300	12"	6	36

PIPE WRENCH - HEAVY DUTY

HIGHLIGHTS

- Drop forged, duly hardened & tempered jaws
- Cr-V steel
- Full painted / Half painted



Din **CrV**

PART NO	DESCRIPTION	PCS / PKT	PCS / CTN
U6700	6"	6	72
U6701	8"	6	36
U6702	10"	6	24
U6703	12"	6	12
U6704	14"	6	12
U6705	18"	2	8
U6706	24"	1	4
U6707	36"	1	2
U6708	48"	1	2

OPEN SLOGGING WRENCH

HIGHLIGHTS

- Duly hardened & Tempered
- Striking end for heavy duty use
- Cr-V Steel / Open end



PART NO	DESCRIPTION	PCS / PKT	PCS / CTN
U1324	24 MM	1	50
U1327	27 MM	1	25
U1330	30 MM	1	25
U1332	32 MM	1	25
U1336	36 MM	1	20
U1341	41 MM	1	20
U1346	46 MM	1	20
U1350	50 MM	1	10
U1355	55 MM	1	10
U1360	60 MM	1	5
U1365	65 MM	1	5
U1370	70 MM	1	5
U1375	75 MM	1	5
U1380	80 MM	1	4
U1385	85 MM	1	4
U1390	90 MM	1	3
U1395	95 MM	1	3
U13100	100 MM	1	2
U13105	105 MM	1	2
U13110	110 MM	1	2
U13115	115 MM	1	2
U13120	120 MM	1	2
U12125	125 MM	1	2

PART NO	DESCRIPTION	PCS / PKT	PCS / CTN
U6924	24 MM	1	25
U6927	27 MM	1	25
U6930	30 MM	1	25
U6932	32 MM	1	25
U6936	36 MM	1	25
U6941	41 MM	1	10
U6946	46 MM	1	10
U6950	50 MM	1	10
U6955	55 MM	1	10
U6960	60 MM	1	10
U6965	65 MM	1	10
U6970	70 MM	1	5
U6975	75 MM	1	5
U6980	80 MM	1	5
U6985	85 MM	1	5
U6990	90 MM	1	4
U6995	95 MM	1	4
U69100	100 MM	1	2
U69105	105 MM	1	2
U69110	110 MM	1	2
U69115	115 MM	1	2
U69120	120 MM	1	2
U69125	125 MM	1	2
U69130	130 MM	1	2
U69135	135 MM	1	2
U69140	140 MM	1	2
U69145	145 MM	1	2
U69150	150 MM	1	1

RING SLOGGING WRENCH

HIGHLIGHTS

- Duly hardened & Tempered
- Striking end for heavy duty use
- Cr-V Steel / Ring end





TYRE LIVER

Din **CrV**



HIGHLIGHTS

- Drop forged
- Cr-V Steel
- Bright chrome

PART NO	DESCRIPTION	PCS / PKT	PCS / CTN
U6714	12"	1	20
U6715	16"	1	20
U6716	20"	1	20
U6717	24"	1	20

HAND SHOVEL

HIGHLIGHTS

- Pointed long
- Wood handle
- Matt black color



PART NO	DESCRIPTION	PCS / PKT	PCS / CTN
U40403	LONG	1	12



PICK AXE WITH FIBER HANDLE

HIGHLIGHTS

- Drop forged carbon steel
- Polished edge
- Light weight for easy to use

PART NO	PCS / PKT	PCS / CTN
U40402	1	6



CHAIN PIPE WRENCH



HIGHLIGHTS

- Handle drop forged with high quality carbon steel
- Body heat treatment, chrome plated

PART NO	SIZE	→ ⊙ ←		L (MM)	MEASUREMENT (MM)	PCS/ PKT	PCS/ CTN
		IN	MM				
U6730	9"	4"	110	9	33.5x28.5x30.5	1	36

BELT WRENCH



HIGHLIGHTS

- Handle drop forged with high quality carbon steel
- Body heat treatment, chrome plated

PART NO	SIZE	→ ⊙ ←		L (MM)	MEASUREMENT (MM)	PCS/ PKT	PCS/ CTN
		IN	MM				
U6739	9"	4"	110	9	35x32x51	1	60

STRAP WRENCH ALUMINIUM HANDLE



HIGHLIGHTS

- Aluminium handle
- Strong wollen nylon strap

PART NO	L (MM)	→ ⊙ ←	MEASUREMENT (MM)	PCS/ PKT	PCS/ CTN
U6743	12"	3"	43x33.5x31	1	40

PIPE WRENCH CHAIN TYPE HEAVY DUTY



HIGHLIGHTS

- Jaw drop-forged
- Jaw teeth induction quenched for durable using
- Dual side jaw for easy change
- Used for pipe construction oil field production and drilling operations

PART NO	SIZE	→ ⊙ ←		L (MM)	CHAIN LENGTH (MM)	MEASUREMENT (MM)	PCS/ PKT	PCS/ CTN
		IN	MM					
U6734	4"	4"	100	900	747	94x18.5x19.5	1	4
U6736	6"	6"	150	1000	897	103x20.5x10.5	1	2
U6737	8"	8"	200	1200	1048	122x20x5x10.5	1	2

OIL FILTER WRENCH

Din CrV



HIGHLIGHTS

- Drop forged.
- Two way oil filter wrench, 3 leg 63 - 102 drive removal filter tool

PART NO	DESCRIPTION	PCS / PKT	PCS / CTN
U6128	63 - 102 2W	1	25

BEARING PULLERS - HEAVY DUTY

HIGHLIGHTS

- Two legs
- Heavy duty
- Crv steel
- Drop Forged
- Inside and outside reversible Jaws
- Bright Chrome

Din CrV



PART NO	DESCRIPTION	PCS / PKT	PCS / CTN
U6130	3"	1	20
U6131	4"	1	20
U6132	5"	1	10
U6133	6"	1	12
U6134	8"	1	5
U6135	10"	1	4
U6136	12"	1	2

BEARING PULLERS - SUPER DUTY

Din CrV



HIGHLIGHTS

- Three legs
- Heavy duty
- Crv. Steel
- Drop Forged
- Inside and outside reversible Jaws
- Bright Chrome

PART NO	DESCRIPTION	PCS / PKT	PCS / CTN
U6140	3"	1	20
U6141	4"	1	20
U6142	5"	1	10
U6143	6"	1	10
U6144	8"	1	4
U6145	10"	1	4
U6146	12"	1	2

BEARING PULLER - THREE JAW

HIGHLIGHTS

- Three legs
- Heavy duty
- Crv steel
- Drop Forged
- Inside and outside reversible Jaws
- Bright Chrome

Din CrV



PART NO	DESCRIPTION	PCS / PKT	PCS / CTN
UT1010	3"	1	50
UT1011	4"	1	40
UT1012	6"	1	20
UT1013	8"	1	12
UT1014	10"	1	6
UT1015	12"	1	4

BEARING PULLER - TWO JAW

HIGHLIGHTS

- Two legs
- Crv steel
- Drop Forged
- Inside and outside reversible Jaws
- Bright Chrome



PART NO	DESCRIPTION	PCS / PKT	PCS / CTN
UT1020	3"	1	50
UT1021	4"	1	40
UT1022	6"	1	20
UT1023	8"	1	16
UT1024	10"	1	8
UT1025	12"	1	4

2 SETS BEARING SEPARATOR ASSEMBLY

HIGHLIGHTS

- Forged with Chrome - Vanadium Steel
- Wholly heat treated high intensity, tenacity
- 2" Bearing Separator
- 3" Bearing Separator



PART NO	DESCRIPTION	PCS / PKT	PCS / CTN
U6191	45.5x30x26	1	2

HYDRAULIC SEPARATOR PULLER SET

HIGHLIGHTS

- Forged with Chrome - Vanadium Steel
- Wholly heat treated high intensity, tenacity
- Mainly used for the dismantlement of gear and bearing
- 4" Bearing Separator



PART NO	DESCRIPTION	PCS / PKT	PCS / CTN
U6192	46x21x17	1	2

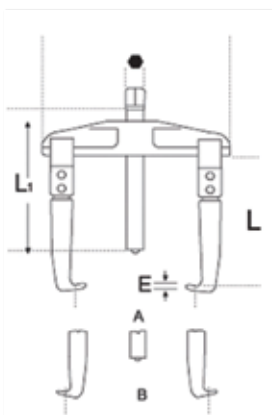

TWO ARM GEAR PULLER

HIGHLIGHTS

- Beam drop-forged
- Joint plate and jaws drop- forged, heat treatment
- Protective case on screw top for easily use
- Puller arm design for confined spaces

PART NO	SIZE	A MAX MM	MIN B MAX MM	L	L1	MEASUREMENT	E MM	T MAX.T	PCS / PKT	PCS / CTN
U6161	90x100	90	70-130	100	M14x1.5x130	34x28x17	3	4.5	1	20
U6162	130x100	130	80-180	100	M14x1.5x130	34x33x18	3	4.5	1	20
U6163	160x150	160	105-220	150	M20x2x210	25.5x21x27	4.5	6.5	1	6
U6164	200x150	200	120-270	150	M20x2x210	25.5x24x31.5	4.5	6.5	1	6
U6165	250x200	250	160-330	205	M27x2x280	35.5x34.5x20.5	6.2	8.5	1	3
U6166	350x200	350	160-420	205	M27X2X280	40.5x35x15	6.2	8.5	1	2
U6167	520x200	520	195-600	205	M27X2X280	62X36X13.5	6.2	8.5	1	2

PRESSURE SCREW SEPERATOR PULLER SET



HIGHLIGHTS

- Forged with Chrome - Vanadium Steel
- Wholly heat treated high intensity, tenacity
- 4" Bearing Separator

PART NO	DESCRIPTION	PCS / PKT	PCS / CTN
U6193	46x21x17	1	3

BEARING SEPARATOR



HIGHLIGHTS

- Drop Forged with Chrome - Vanadium Steel
- Can reach places where puller jaws cannot fit
- Convenient and easy to use

PART NO	SIZE	MAX (MM)	MIN (MM)	A (MM)	B (MM)	PCS/ PKT	PCS/ CTN
U6181	2"	50	30	3/8"-16	61	1	25
U6182	3"	75	50	3/8"-16	92	1	10
U6183	4"	105	75	3/2"-12	111	1	8
U6184	6"	150	100	5/8"-11	156	1	4

BEARING SEPARATOR NEW

HIGHLIGHTS

- Drop Forged with Chrome - Vanadium Steel
- Can reach places where puller jaws cannot fit
- Convenient and easy to use



PART NO	SIZE	MAX (MM)	MIN (MM)	PCS/ PKT	PCS/ CTN
U6172	3"	75	50	1	10

ARMATURE BEARING PULLER



HIGHLIGHTS

- Ideal for pulling bearing from electrical Tools and auto electrical equipment such as generators, alternators starter bearing & bushing
- Forged & hardened
- Chrome - vanadium
- Steel Construction

PART NO	SIZE	(MM)	MEASUREMENT	PCS/ PKT	PCS/ CTN
U6151	1"	19.35	34.5X25.5X38	10	60
U6152	2"	24.55	37.5X24.5X46	10	30
U6153	3"	33.80	38.5X33.5X20.5	4	16

PILOT BEARING PULLER



HIGHLIGHTS

- Removes all sleeve - type bearing with 1/2" - 2" inside diameter
- Removes Pilot bearings pump bearings, bushings etc

PART NO	SIZE	MEASUREMENT	PCS / CTN
U6742	2"	49.5x31.5x27	20

The great appeal — in fact the entire point — of pliers and adjustable wrenches is handiness. They should be versatile, durable and designed to accomplish tasks efficiently. The cutting pliers feature a special pivot design which delivers greater leverage and, therefore, reduces cutting effort.

Bi-material handle provides a comfortable and secure grip



Drop-forged from high-CR-Ni steel for increased durability



SIDE CUTTING PLIERS

HIGHLIGHTS

- Inductin hardened
- Cr - Ni Steel
- Natural polish
- Double colour sleeve

PART NO	DESCRIPTION	PCS / PKT	PCS / CTN
U35-150	6"	6	48
U35-175	7"	6	48



COMBINATION PLIERS

HIGHLIGHTS

- Inductin hardened
- Cr - Ni Steel
- Natural polish
- Double colour sleeve



Din **Cr-Ni**

PART NO	DESCRIPTION	PCS / PKT	PCS / CTN
U34-150	6"	6	48
U34-175	7"	6	48
U34-200	8"	6	48

GROOVE JOINT / MONKEY PLIERS

HIGHLIGHTS

- Induction hardened.
- Cr - V Steel
- Hardened & Tempered
- Natural polish
- With double colour sleeve



Din **Cr-V**

PART NO	DESCRIPTION	PCS / PKT	PCS / CTN
U38-200	8"	6	-
U38-250	10"	6	48
U38-300	12"	6	-

LONG NOSE / NEEDLE NOSE PLIERS



HIGHLIGHTS

- Inductin hardened
- Cr - Ni Steel
- Natural polish
- Double colour sleeve

Din **Cr-Ni**

PART NO	DESCRIPTION	PCS / PKT	PCS / CTN
U36-150	6"	6	48
U36-200	8"	6	48

WIRE STRIPPER AUTO



Din **Cr-V**

HIGHLIGHTS

- Die cast body and frame provide durability and strength
- Awg size mentioned at each cutting position
- Adjustable stripping length guide provides consistent uniform strip length

PART NO	DESCRIPTION	PCS / PKT	PCS / CTN
U6122	AWG - 0.5 / 1.2 / 1.6 / 2.0 / 2.6 / 3.2	10	50

WIRE STRIPPER F STYLE

HIGHLIGHTS

- 2 in 1, wire stripper & Cutter
- Applicable wire stripper size < 0.5MM² - 6MM²
- Self-adjusting mechanism according to wire size provide excellent wire stripping w/o
- Adjustable stop for consistency in wire strip lengths.
- Replaceable blade system.
- Simple adjustment dial for blade ressure according to the thickness of insulation
- Light weight, handy and excellent durability
- Caution: Do not use for cutting high carbon steel wire

		STRIP	CUT
WIRE	(DIA. MM)	0.5 - 2	0.32 - 1.6
	(SECTION MM2)	0.2 - 3.3	0.08 - 2.0
	(AWG NO.)	24 - 10	24 - 14
TWIST WIRE	(SECTION MM2)	0.2 - 5.5	0.09 - 3.5
	(AWG NO.)	24 - 10	24 - 12
RIBBON CABLE	(SECTION MM2)	02 - 05	8 MM
	(AWG NO.)	24 - 20	24 - 20



PART NO	PCS / PKT	PCS / CTN
U6121	10	50

Din **Cr-Ni**



COMPOUND COMBINATION PLIER

HIGHLIGHTS

- Heat treated jaws-with Ground finish Ergonomic Bi-material soft grip handle carbon steel
- High quality Uken compound action combination plier which delivers a combination of increased power & comfort

PART NO	DESCRIPTION	PCS / PKT	PCS / CTN
U43-020	8"	-	-

Din **Cr-Ni**



COMPOUND DIAGONAL CUTTING PLIER

HIGHLIGHTS

- Forged vanadium steel for strength and durability
- Induction hardened edges for long cutting life
- Heat-treated jaws provide exceptionally strong gripping strength

PART NO	DESCRIPTION	PCS / PKT	PCS / CTN
U43-030	8"	-	-

Din **Cr-Ni**



COMPOUND END CUTTING PLIER

HIGHLIGHTS

- Forged vanadium steel for strength and durability
- Induction hardened edges
- Molded - Bi - Material grips for comfort and control
- Heat-treated jaws with ground finish, provide exceptionally strong gripping strength

PART NO	DESCRIPTION	PCS / PKT	PCS / CTN
U43-010	8"	-	-



VDE COMBINATION PLIER



HIGHLIGHTS

- Drop forged chrome vanadium steel
- Dual Compound handle
- Cutting face to stay sharper ,Longer

PART NO	DESCRIPTION	PCS / PKT	PCS / CTN
U39-150	6"	1	-
U39-175	7"	1	-
U39-200	8"	1	-



VDE DIAGONAL CUTTING PLIER 6"

HIGHLIGHTS

- Dynamic joint ensure 40% less force Required for cutting
- It cuts hard wire up to 2mm

PART NO	DESCRIPTION	PCS / PKT	PCS / CTN
U41-150	6"	1	-



VDE LONG NOSE PLIER

HIGHLIGHTS

- Compact plier with Extended Nose
- Easy cripping , manipulating and Placing of small parts of wire
- Cutting edge is suitable for flutand round cable

PART NO	DESCRIPTION	PCS / PKT	PCS / CTN
U41-200	8"	1	-



VDE STRIP PLIER

- Manufactured to exacting European standars individually tested to 10,000 volts and approved for working around live circuits that do no exceed 1000 volts
- The bi-material handle offer the user improved control

PART NO	DESCRIPTION	PCS / PKT	PCS / CTN
U42-150	6"	1	-





AVIATION TIN SNIPS STRAIGHT

HIGHLIGHTS

- Cut tin, Duct work, Soffit & Other materials
- Compound hinges delivers more force with less effort
- Non-slip cushioned handle grips reduce fatigue

PART NO	DESCRIPTION	PCS / PKT	PCS / CTN
U37-010	STRAIGHT	1	

AVIATION TIN SNIPS LEFT

HIGHLIGHTS

- These light weight yet powerful tin snips gives you the power to cut through tin and sheet metal with little effort

PART NO	DESCRIPTION	PCS / PKT	PCS / CTN
U37-020	LEFT	1	



AVIATION TIN SNIPS RIGHT

HIGHLIGHTS

- Cut tin, Duct work, Soffit & Other materials
- Compound hinges delivers more force with less effort
- Non-slip cushioned handle grips reduce fatigue

PART NO	DESCRIPTION	PCS / PKT	PCS / CTN
U37-030	RIGHT	1	



The Uken end cutter is a high quality finish on all type of cutting edges for soft and hard wire. Also suitable for twisting & cutting binding wire. End cutter also has polished head



Induction hardened cutting edge stays sharper, longer



END CUTTER



HIGHLIGHTS

- Cutting edge for soft and hardwire
- Suitable for twisting and cutting binding wire

PART NO	DESCRIPTION	PCS / PKT	PCS / CTN
U10-001	6"	1	-
U10-002	7"	1	-
U10-003	8"	1	-

PIPE CUTTER - 42 MM PVC



HIGHLIGHTS

- For cutting PVC, copper & aluminium pipes
- Stainless steel blade for long life
- Precision cutting

PART NO	DESCRIPTION	PCS / PKT	PCS / CTN
U6111	42 MM	10	50

PIPE CUTTER - 75 MM PVC



HIGHLIGHTS

- For cutting PVC, copper & aluminium pipes
- High quality blade for long life
- Precision cutting

PART NO	DESCRIPTION	PCS / PKT	PCS / CTN
U6112	75 MM	2	10

TUBE CUTTER - MINI



HIGHLIGHTS

- For cutting thin copper, brass and aluminium tubes
- High precision cutting
- High quality blade for long life

PART NO	DESCRIPTION	PCS / PKT	PCS / CTN
U6100	3 X 22 MM	10	50

TUBE CUTTER - 3-30 MM



HIGHLIGHTS

- For cutting rigid plastic pipes, copper and aluminium tubes
- High precision cutting
- High quality blade for long life

PART NO	DESCRIPTION	PCS / PKT	PCS / CTN
U6101	3 X 30 MM	12	60

TUBE CUTTER - 6-42 MM



HIGHLIGHTS

- For cutting rigid plastic pipes, copper and aluminium tubes
- High precision cutting
- High quality blade for long life

PART NO	DESCRIPTION	PCS / PKT	PCS / CTN
U6102	6-42 MM	10	50

TUBE CUTTER - 6-67 MM



HIGHLIGHTS

- For cutting rigid plastic pipes, copper and aluminium, plastic tubes
- High quality blade for long life
- High precision cutting

PART NO	DESCRIPTION	PCS / PKT	PCS / CTN
U6103	6-67 MM	5	20

TUBE CUTTER - 50-127 MM



HIGHLIGHTS

- For cutting rigid plastic pipes, copper and aluminium, plastic tubes
- High quality blade for long life
- High precision cutting

PART NO	DESCRIPTION	PCS / PKT	PCS / CTN
U6104	50-127 MM	2	10

TUBE CUTTER - 100-168 MM



HIGHLIGHTS

- For cutting rigid plastic pipes, copper and aluminium, plastic tubes
- High quality blade for long life
- High precision cutting

PART NO	DESCRIPTION	PCS / PKT	PCS / CTN
U6105	100-168 MM	2	10

TUBE CUTTER WHEEL



HIGHLIGHTS

- For cutting rigid plastic pipes, copper and aluminium, plastic tubes
- High quality blade for long life
- High precision cutting

PART NO	DESCRIPTION	PCS / PKT	PKT / CTN
U610018	3-22	2	250
U610110	3-30	2	250
U610212	6-42	2	250
U610313	6-67	2	250
U610414	50-127	2	250
U610515	100-168	2	250

PIPE VISE / BENCH YOKE VISE

HIGHLIGHTS

- Hardened & Tempered jaws
- Malleable iron
- Chrome plated spindle
- Painted body



PART NO	DESCRIPTION	PCS / PKT	PCS / CTN
U6720	2"	1	4
U6721	2.5"	1	2
U6722	3"	1	2
U6723	4"	1	2



BENCH TYPE BOLT CUTTER

HIGHLIGHTS

- Head drop-forged with CrV Steel
- Full body special heat treatment
- Cutting edges induction quenched
- Joint arms drop forged
- Base measures 3 x 6" (76 x 152 mm)
- Operating by one hand for easy cutting

PART NO	SIZE	SOFT MATERIAL	MEDIUM MATERIAL	MEASUREMENT (CM)	PCS / PKT	PCS / CTN
U6840	24"	5 (MN)	3/16"	57 X 29 X 21	1	2

HAND TOOLS

BENCH TYPE BOLT CUTTER 3 IN 1

HIGHLIGHTS

- Combination tools of bolt cutter / swagger /wire rope cutter
- Interchangeable head for cutting rods <HRC40 wire rope 14mm
- Steel wires <10mm and swagging tool Aluminium sleeve



PART NO	HEAD	SOFT MATERIAL	MEDIUM MATERIAL	MEDIUM MATERIAL	MEDIUM MATERIAL	MEDIUM MATERIAL	MEDIUM MATERIAL	SIZE	SOFT ROAD (CM)	PCS / PKT	PCS / CTN
U6841	I	10(MM)	8(MM)	-	-	-	-	24"	57 X 29 X 21	1	2
	II	-	-	14(MM)	15(MM)	-	-	24"	57 X 29 X 21		
	III	-	-	-	-	6(MM)	3/16"	24"	57 X 29 X 21		

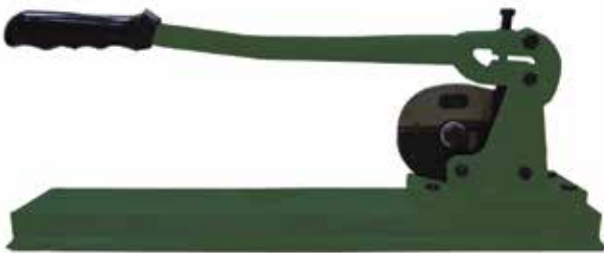

BENCH TYPE WIRE ROPE CUTTER HEAVY DUTY

HIGHLIGHTS

- Head drop-forged with CrV steel Blade drop forged
- Joint arms drop-forged base measures 3x6" (76x152cm)
- Operating by one hand for easy cutting
- Used for cutting steel wire ,piano wire AGSR cable and aircraft cable industry class quality

PART NO	SIZE	SOFT MATERIAL	MEDIUM MATERIAL	MEASUREMENT (CM)	PCS / PKT	PCS / CTN
U6815	24"	12(MM)	10(MM)	57 X 29 X 21	1	2

BOLT CUTTER - MINI

HIGHLIGHTS

- Cr-V steel
- Blade drop forged
- With sleeve lugs for high grip



PART NO	DESCRIPTION	PCS / PKT	PCS / CTN
U6800	8"	6	60

BOLT CUTTER - HEAVY DUTY

HIGHLIGHTS

- Duly hardend and tempered
- Cr-V Steel
- Blade drop forged
- With sleeve lugs for high grip



PART NO	DESCRIPTION	PCS / PKT	PCS / CTN
U6801	12"	1	20
U6802	14"	1	20
U6803	18"	1	12
U6804	24"	1	8
U6805	30"	1	5
U6806	36"	1	4
U6807	42"	1	2



WIRE ROPE CUTTER - POCKET TYPE

HIGHLIGHTS

- Cr-V Steel
- Blade drop - forge with Crv, drop forge adaptor
- With sleeve lugs for high grip



PART NO	DESCRIPTION	PCS / PKT	PCS / CTN
U6810	8"	6	60

WIRE ROPE CUTTER

HIGHLIGHTS

- Baldes drop - forged with high quality alloy steel-Crv
- Drop - forged adaptor
- With sleeve lugs for high grip

PART NO	DESCRIPTION	PCS / PKT	PCS / CTN
U6811	18" HEAVY DUTY	1	10
U6812	24" HEAVY DUTY	1	8
U6813	36" HEAVY DUTY	1	4
U6814	42" HEAVY DUTY	1	3



Din **CrV**

CABLE CUTTER - COMPACT

HIGHLIGHTS

- Cr-V.Steel
- High - Leverage jaws with shear cut blades
- With sleeve lugs

PART NO	DESCRIPTION	PCS / PKT	PCS / CTN
U6823	10"	5	50

CABLE CUTTER - MINI



Din **CrV**

HIGHLIGHTS

- Cr-V. Steel
- Blades drop - forged
- With sleeve lugs for high grips

PART NO	DESCRIPTION	PCS / PKT	PCS / CTN
U6820	6"	5	50
U6821	8"	5	50
U6822	10"	5	50

CABLE CUTTER



Din **CrV**

HIGHLIGHTS

- Duly hardened & Tempered
- Cr-V. Steel
- High leverage jaws with shear cut blades
- With sleeve lugs for high grip

PART NO	DESCRIPTION	PCS / PKT	PCS / CTN
U6826	24"	1	12
U6827	32"	1	4

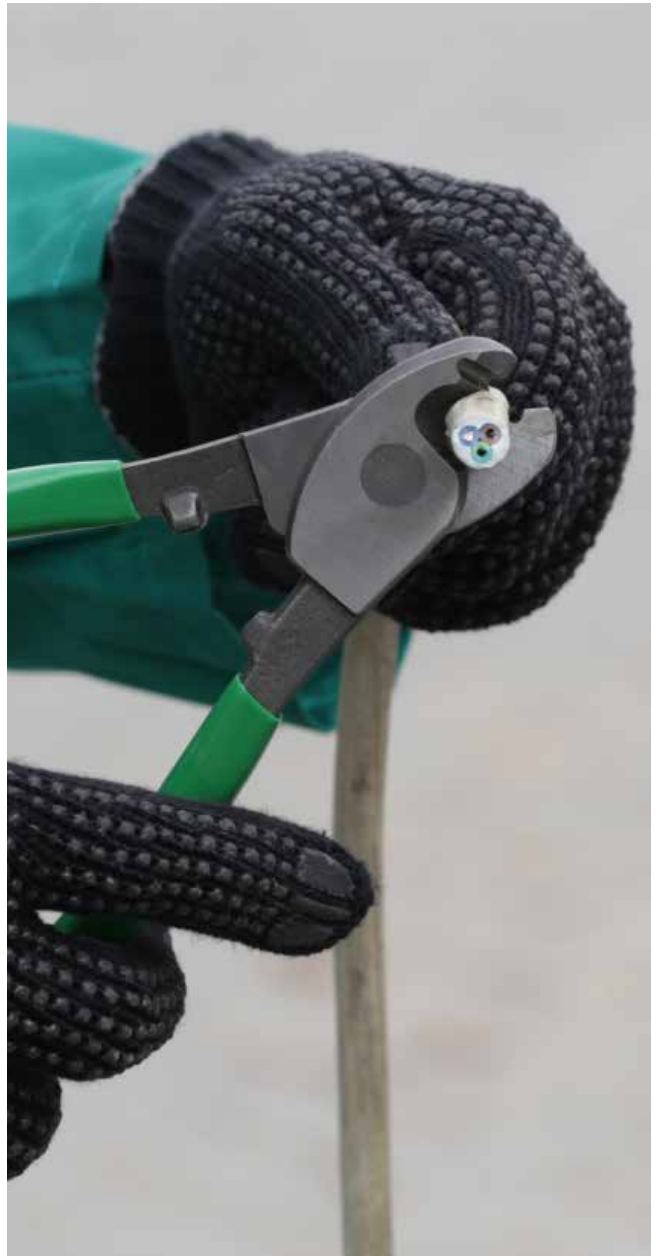



CABLE CUTTER - ALUMINIUM HANDLE

Din **CrV**

HIGHLIGHTS

- Aluminium handle
- Alloy steel blade
- With sleeve lugs for high grip

PART NO	DESCRIPTION	PCS / PKT	PCS / CTN
U6824	24"	1	10
U6825	32"	1	6

TINMAN'S SNIPPER (SHEET CUTTER)

HIGHLIGHTS

- Cr-V steel
- Blade drop - forged
- With sleeve lugs for high grips
- With or without spring



Din **CrV**

PART NO	DESCRIPTION	PCS / PKT	PCS / CTN
U6831	10"	5	40
U6832	12"	5	20
U6833	14"	5	20

THREADED ROD CUTTER

Din **CrV**



HIGHLIGHTS

- Alloy Steel blades
- Designed to cut Precisely & Cleanly
- Unique die design protects the threaded rod from damage while cutting
- No Cleaning or deburring work necessary after cutting
- It's Faster, cleaner and safer

PART NO	CAPACITY	MEDIUM MATERIALS	PCS / PKT	PCS / CTN
U6851	6 MM	M6	1	1
U6852	8 MM	M8	1	1
U6853	10 MM	M10	1	1
U6854	12 MM	M12	1	1

REBBAR CUTTER & BENDER

Din **CrV**



HIGHLIGHTS

- Alloy Steel blades
- Special designed for cutting and bending of concrete reinforcing rod etc..
- Can be bolted to the floor or a board

PART NO	CAPACITY	L (MM)	PCS / PKT	PCS / CTN
U6862	16 MM (5/8")	1320	1	1
U6863	18 MM (3/4")	1325	1	1

TRI - STAND 2.5" YOKE VICE



HIGHLIGHTS

- Easily clamp pipe for cutting or threading
- Complete with slots for hanging tools, pipe rest, three pipe benders and ceiling brace screw
- Integral legs and tray fold in for easy carrying and setup.

PART NO	MEASUREMENT		PCS/CTN
	IN	MM	
U6725	2 1/2"	76	1



PIPE STAND - ROLLER HEAD

HIGHLIGHTS

- Roller Center pipe will allow to rotate
- Compact and foldable for easy transportation
- Adjustable height
- Ideal use for threading , roll grooving and other pipe work applications

PART NO	HEIGHT ADJUSTMENT LOW - HIGH		MAX PIPE CAPACITY		MAX WEIGHT CAPACITY		MEASUREMENT	PCS / CTN
	IN	CM	IN	CM	LB	KG		
U6732	28-53	71-132	12	300	2500	1134	92x22x22	1



PIPE STAND - V HEAD

HIGHLIGHTS

- Support for Tough pipe joining Demands
- Ergonomic V-Handle
- Angled for a comfortable hand position during transport and height adjustment
- Allows for quick vertical height adjustment

PART NO	HEIGHT ADJUSTMENT LOW - HIGH		MAX PIPE CAPACITY		MAX WEIGHT CAPACITY		MEASUREMENT	PCS / CTN
	IN	CM	IN	CM	LB	KG		
U6731	28-53	71-132	12	300	2500	1134	92x20.5x22.5	1

Uken knives and blades are designed to work together to be more efficient, faster, safer and useful. Its textured, die-cast finish provides a slip-resistant grip and its three-position, retractable blade ensures versatility

Textured, die-cast finish provides a slip-resistant grip

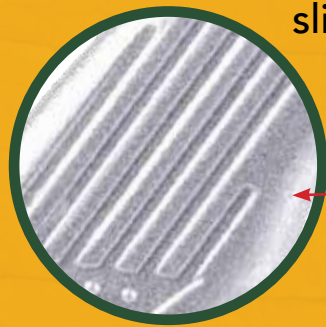

Three-position, retractable blade ensures versatility

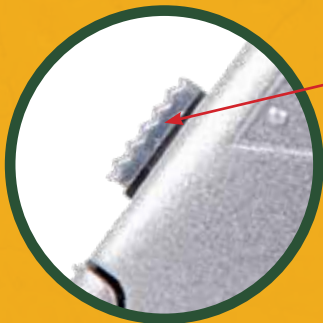

Rugged, all-metal construction stands up to the most extreme uses



UTILITY KNIFE

HIGHLIGHTS

- Smooth, three - level slide exposes variable blade lengths
- Optimized cutting angle for reduced hand fatigue

PART NO	PCS / PKT	PCS / CTN
U6210	12	144

UTILITY SAFETY KNIFE



HIGHLIGHTS

- Push and slide opening blade for free access
- Optimized cutting angle for reduced hand fatigue
- Slim nose for greater control

PART NO	PCS / PKT	PCS / CTN
U6211	12	144

FOLDING KNIFE



HIGHLIGHTS

- Quick - change button for easy blade change
- Best clip for convenient access
- Press button to insert or release button

PART NO	PCS / PKT	PCS / CTN
U6230	12	96



UTILITY BLADE



PART NO	PCS / PKT	PKT / INNER CTN	PKT / CTN
U6243	5	20	400
U6241	10	20	400
U6242	100	6	48

UTILITY HOOK BLADE



PART NO	PCS / PKT	PKT / INNER CTN	PKT / CTN
U6244	5	20	400

These blades are built to last twice as long as traditional blades



SNAP - OFF CUTTER

HIGHLIGHTS

- Ergonomically shaped body with soft grip for comfort in use
- Solid and durable stainless steel cartridge
- Locking button system for enhanced safety

PART NO	PCS / PKT	PCS / CTN
U6214	12	96



AUTO - RELOAD KNIFE



HIGHLIGHTS

- Ergonomically shaped body with soft grip for comfort in use
- Solid and durable stainless steel cartridge
- Automatically reloading blades
- Blade lock knob for enhanced safety

PART NO	PCS / PKT	PCS / CTN
U6213	12	96

METAL KNIFE - POCKET TYPE



HIGHLIGHTS

- Slim design fits in your pocket
- Durable steel construction
- Blade lock knob for enhanced safety

PART NO	PCS / PKT	PCS / CTN
U6212	24	288

KNIFE (ABS07-TPR)



HIGHLIGHTS

- Universal knife
- Ratchet lock system
- TPR handle with high grip
- 2 pc extra blade stored inside

PART NO	DESCRIPTION	PCS / PKT	PCS / CTN
U6201	18 MM BLADE	12	144

KNIFE (ABS19-TPR)



HIGHLIGHTS

- Universal knife
- Sliding lock system
- TPR handle with high grip
- 2 pc extra blade stored inside

PART NO	DESCRIPTION	PCS / PKT	PCS / CTN
U6202	18 MM BLADE	12	144



KNIFE (ABS21)



HIGHLIGHTS

- Universal Knife
- Ratchet lock system
- 2 pc extra blade stored inside

PART NO	DESCRIPTION	PCS / PKT	PCS / CTN
U6203	18 MM BLADE	12	144

KNIFE PROFESSIONAL (ABS - TPR)



HIGHLIGHTS

- Professional Cutter.
- With automatic blade tracking 8 pcs blades
- TPR handle with high grip

PART NO	DESCRIPTION	PCS / PKT	PCS / CTN
U6204	18 MM BLADE	12	96

KNIFE (ABS15-TPR) SMALL

HIGHLIGHTS

- Universal knife
- Sliding lock system
- TPR handle with high grip
- 2pc extra blades stored inside



PART NO	DESCRIPTION	PCS / PKT	PCS / CTN
U6205	9 MM BLADE	24	432

KNIFE PROFESSIONAL (ABS-TPR) SMALL



HIGHLIGHTS

- Universal knife
- Professional cutter
- Automatic blade tracking 4pc blades
- TPR handle with high grip

PART NO	DESCRIPTION	PCS / PKT	PCS / CTN
U6206	9 MM BLADE	24	192

These blades are built to last twice as long as traditional blades

KNIFE BLADES 18 MM



PART NO	DESCRIPTION	PCS / PKT	PCS / CTN
U6207	18 MM	10	300

KNIFE BLADES 9 MM



PART NO	DESCRIPTION	PCS / PKT	PCS / CTN
U6208	9 MM	10	300

METAL KNIFE - POCKET TYPE

PART NO	DESCRIPTION	PCS / PKT	PKT / INNER CTN	PKT / CTN
U6245	9 MM	10	24	576



AUTO - RELOAD KNIFE

PART NO	DESCRIPTION	PCS / PKT	PKT / INNER CTN	PKT / CTN
U6246	18 MM	10	24	288



SNAP - OFF CUTTER

PART NO	DESCRIPTION	PCS / PKT	PKT / INNER CTN	PKT / CTN
U6247	25 MM	10	10	120



The Uken handsaw is a multi-purpose hand point-saw for a highquality finish on all types of wood, laminates & plastic pipes. The handle is a proven design, light and strong with TPR handle for increased hold and enhanced comfort. 90° & 45° angles integrated in the handle aid the user when marking out.

Textured, die-cast finish provides a slip-resistant grip

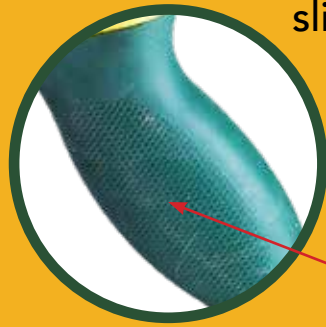

65MM Alloy Steel



Induction-hardened teeth stay sharp up to five times longer than standard teeth



HAND SAW - ABS - TPR HANDLE

HIGHLIGHTS

- Precision ground teeth
- Impulse hardened teeth
- 65 mm alloy steel blade
- TPR handle with high grip

PART NO	DESCRIPTION	PCS / PKT	PCS / CTN
U4571	16"	10	40
U4572	18"	10	40
U4573	20"	10	40
U4574	22"	10	40
U4575	24"	10	40

HAND SAW - WOOD HANDLE



HIGHLIGHTS

- Precision ground teeth
- Impulse hardened teeth
- 65mm alloy Steel Blade

PART NO	DESCRIPTION	PCS / PKT	PCS / CTN
U4561	16"	10	40
U4562	18"	10	40
U4563	20"	10	40
U4564	22"	10	40
U4565	24"	10	40



CARPENTER SAW



HIGHLIGHTS

- Natural wood handle
- Precision ground teeth
- Impulse hardened teeth
- 65mm alloy Steel Blade

PART NO	DESCRIPTION	PCS / PKT	PCS / CTN
U4581	16"	10	60
U4582	18"	10	60

PRUNING SAW - WITH SHEATH



HIGHLIGHTS

- Precision ground teeth and impulse hardened teeth
- TPR handle for high grip, helps reduce hand fatigue so you can cut longer
- Alloy Steel
- Cut 50% faster conventional saws

PART NO	DESCRIPTION	PCS / PKT	PCS / CTN
U4583	12"	10	60

PRUNING SAW - FOLDING TYPE



HIGHLIGHTS

- Precision ground teeth and impulse hardened teeth.
- TPR handle for high grip, helps reduce hand fatigue so you can cut longer
- Alloy Steel
- Cut 50% faster conventional saws
- Locking blade with TPR handle and release button makes it lightweight-and easy to carry

PART NO	DESCRIPTION	PCS / PKT	PCS / CTN
U4584	7"	12	60

JOB SAW



HIGHLIGHTS

- Cut 50% faster
- Precision ground teeth and Impulse hardened teeth
- TPR handle for high grip
- 65 mm alloy steel blade

PART NO	DESCRIPTION	PCS / PKT	PCS / CTN
U4585	6"	12	60

CONCRETE HAND SAW 26" PLASTIC HANDLE



HIGHLIGHTS

- 65MM alloy steel, ergonomic design
- TCT blade, precision ground teeth
- Strong ABS with TPR handle for comfortable grasp

PART NO	DESCRIPTION	PCS / PKT	PCS / CTN
U4586	26"	5	20

CONCRETE HAND SAW 26" WOOD HANDLE



HIGHLIGHTS

- 65MM alloy steel, ergonomic design
- TCT blade, precision ground teeth
- Beech wood handle

PART NO	DESCRIPTION	PCS / PKT	PCS / CTN
U4587	26"	5	20

CONCRETE HAND SAW 18" WOOD HANDLE



HIGHLIGHTS

- 65MM alloy steel, ergonomic design
- TCT blade, precision ground teeth
- Beech wood handle

PART NO	DESCRIPTION	PCS / PKT	PCS / CTN
U4588	18"	5	20



HACKSAW BLADE



HIGHLIGHTS

- Super efficient, Bi-metal 8% cobalt blade for superior cutting performance
- Unbreakable, Sharp teeth & Flexible
- Corrosion Resistance
- Ideal for use on tough materials

PART NO	L X W	TEETH	PCS / PKT	PKT / CTN
U4554	300MM X 13MM	18	50	20
U4555	300MM X 13MM	24	50	20
U4556	300MM X 13MM	32	50	20



HACKSAW - HEAVY DUTY

HIGHLIGHTS

- Heavy Duty Industrial quality Hack saw
- Strong Aluminium die cast handle with TPR for control & comfort
- Efficient and easy to use adjustable lever

PART NO	DESCRIPTION	PCS / PKT	PCS / CTN
U4557	300 MM	1	12

HACKSAW FRAME

HIGHLIGHTS

- TPR handle for high grip
- Strong die casted frame
- Easy to operate



PART NO	DESCRIPTION	PCS / PKT	PCS / CTN
U4552	12"	10	20

HACKSAW FRAME - MINI

HIGHLIGHTS

- Strong die casted frame
- Plastic handle



PART NO	DESCRIPTION	PCS / PKT	PCS / CTN
U4553	6"	10	80

HACKSAW - MINI

HIGHLIGHTS

- Light weight and TPR handle for comfort & control
- Ideal for cutting in small, hard to reach areas, durable and comfortable to use accepts both 10"/250mm and 12"/300mm
- Blade Supplied with 12"/300mm



PART NO	DESCRIPTION	PCS / PKT	PCS / CTN
U4558	300 MM	5	20

TOOL BOX 21" - WITH SINGLE HANDLE



TOOL BOX ORANGE



HIGHLIGHTS

- 5 Tray tool box
- Ideal for storing and transporting wide range of tools
- Powder coated finish for long life
- Provided 2 handles for 100% access

PART NO	DESCRIPTION	PCS / PKT	PCS / CTN
203M	18"	1	4
204M	21"	1	4

TOOL BOX BLUE/GRAY HEAVY DUTY



HIGHLIGHTS

- 5 Tray tool box
- Ideal for storing and transporting wide range of tools
- Powder coated finish for long life
- Provided 2 handles for 100% access

PART NO	DESCRIPTION	PCS / PKT	PCS / CTN
101H	18"	1	4
102H	21"	1	4

HIGHLIGHTS

- 5 Tray tool box
- Ideal for storing and transporting wide range of tools
- Powder coated finish for long life
- Provides single handle for 100% access

PART NO	DESCRIPTION	PCS / PKT	PCS / CTN
408S	21"	1	4

TOOL BOX



HIGHLIGHTS

- 5 Tray tool box
- Ideal for storing and transporting wide range of tools
- Powder coated finish for long life
- Provided 2 handles for 100% access

PART NO	DESCRIPTION	PCS / PKT	PCS / CTN
305U	18"	1	4
306U	21"	1	4

TOOL BOX - PLASTIC



HIGHLIGHTS

- Plastic tool box with tray and organizer
- Soft grip handle for better comfort
- Easy to carry and store
- Available in different sizes

PART NO	DESCRIPTION	PCS / PKT	PCS / CTN
312P	12"	1	N/A
314P	14"	1	N/A
316P	16.5"	1	N/A
318P	18.5"	1	N/A
321P	21"	1	N/A
324P	23.5"	1	N/A

TOOL BOX PROFESSIONAL



HIGHLIGHTS

- New Design Heavy - Duty Plastic Tool box is built for professional use with durable impact.
- Wide opening for bulk storage & easy access

PART NO	DESCRIPTION	PCS / PKT	PCS / CTN
U8320	450 MM	1	6
U8321	520 MM	1	2

TOOL BOX PLASTIC HEAVY DUTY



HIGHLIGHTS

- This Dry box is ideal for both commercial & Industrial application
- Extra thick Copolymer Construction stand up to extreme weather & rough handling

PART NO	DESCRIPTION	PCS / PKT	PCS / CTN
U8310	412.5 MM	1	6
U8311	475 MM	1	4

TOOL BAG



HIGHLIGHTS

- High quality, heavy duty Denier polyester material
- Large storage space for hand tools & accessories
- Shoulder & Hand strap for easy carrying on hand & shoulder
- Zipper on top easy access

PART NO	DESCRIPTION	PCS / PKT	PCS / CTN
U8301	14"	1	10
U8300	15"	1	10

BACKPACK



HIGHLIGHTS

- Waterproof material
- Smaller than 17" laptop
- USB port

PART NO	PCS / PKT	PCS / CTN
LP - 1701	1	8

TOOL POUCH SINGLE



HIGHLIGHTS

- High quality, heavy duty with denier polyester material
- One large pocket, one medium pocket, three sleeves, outer four slots to accommodate a variety of hand tools & accessories
- Small, light weight & strong

PART NO	DESCRIPTION	PCS / PKT	PCS / CTN
U8303	SINGLE	1	20

TOOL BAG



HIGHLIGHTS

- High quality, heavy duty Denier polyester material
- One open large mouth, two large pockets, twenty medium size of pockets and seven small size pockets for easy access type of tools & accessories
- Shoulder & hand strap for easy carrying

PART NO	DESCRIPTION	PCS / PKT	PCS / CTN
U8302	20"	1	4

TOOL BELT DOUBLE WITH BELT



HIGHLIGHTS

- High quality, heavy duty with denier polyester material
- Two large pocket, four medium pocket, three small pockets, two sleeves, two hammer hooks and two extra small pockets with four slots
- Hand strap to easy carry

PART NO	DESCRIPTION	PCS / PKT	PCS / CTN
U8304	DOUBLE	1	10

BELT ONLY



PART NO	DESCRIPTION	PCS / PKT	PCS / CTN
U8305	BELT	1	-

JERRY CAN

HIGHLIGHTS

- Heavy duty steel construction
- Built-in carry handle
- Locking metal cap
- Rubber gasket seal
- Coated interior

PART NO	DESCRIPTION	PCS / CTN
505U	20 LITRE	4



JERRY CAN SPOUT TUBE

PART NO	PCS / CTN
506U	1



GLASS HOLDER / SUCKER - HEAVY DUTY



HIGHLIGHTS

- Secure connection for long time
- Ergonomic - designed rigid handle makes it much easier to lift loads
- Secure hold the black clamping leaven provides quick and reliable suction

PART NO	DESCRIPTION	PCS / PKT	PCS / CTN
U9502	80 KG (DOUBLE HEAD)	1	10

GLASS HOLDER / SUCKER - HEAVY DUTY



HIGHLIGHTS

- Secure connection for long time
- Ergonomic - designed rigid handle makes it much easier to lift loads
- Secure hold the black clamping leaven provides quick and reliable suction

PART NO	DESCRIPTION	PCS / PKT	PCS / CTN
U9503	150 KG (TRIPLE HEAD)	1	10

ABRASSIVES & CIRCULAR SAW BLADES



CUTTING DISC - METAL



HIGHLIGHTS

- Fast cutting
- Superior resin bond
- Low vibration level

PART NO	DESCRIPTION	SPECIFICATION	PCS/PKT	PCS/CTN
UK1003016	100 X 3.0 X 16 MM	A30 R-BF	50	200
UK11530222	115 X 3.0 X 22.2 MM	A30 R-BF	50	200
UK12530222	125 X 3.0 X 22.2 MM	A30 R-BF	50	200
UK18030222	180 X 3.0 X 22.2 MM	A30 R-BF	25	100
U23030222	230 X 3.0 X 22.2 MM	A30 R-BF	25	50

GRINDING DISC - METAL

HIGHLIGHTS

- Fast grinding & Polishing
- Superior resin bond
- Comfortable working
- Low vibration levels



PART NO	DESCRIPTION	SPECIFICATION	PCS/PKT	PCS/CTN
UK1006016	100 X 6 X 16 MM	A24R-BF	25	100
UK11560222	115X6.0X22.23 MM	A24R-BF	25	100
UK12560222	125X6.0X22.23 MM	A24R-BF	25	100
UK18060222	180X6.0X22.23 MM	A24R-BF	25	50
UK23060222	230X6.0X22 MM	A24R-BF	15	30

CUT-OFF WHEEL



HIGHLIGHTS

- For all ferrous materials
- Fast cutting
- Superior resin bond
- Comfortable working

PART NO	DESCRIPTION	SPECIFICATION	PCS/PKT	PCS/CTN
UK30032254	300 X 3.2 X 25.4 MM	A30 R-BF	1	25
UK35532254	355 X 3.2 X 25.5 MM	A30 R-BF	1	25
UK40032254	400 X 3.2 X 25.4	A30 R-BF	1	25

THIN WHEEL - INOX



HIGHLIGHTS

- Fast cutting can cut steel, ss, aluminium & copper
- Superior resin bond
- Low vibration level

PART NO	DESCRIPTION	SPECIFICATION	PCS/PKT	PCS/CTN
UK100161F	100 X 1.0 X 16 MM	A46 R-BF	100	400
UK11510222	115 X 1.0 X 22.2 MM	A46 R-BF	100	400
UK1001616	100 X 1.6 X 22.2 MM	A46 R-BF	100	400
UK11516222	115 X 1.6 X 22.2 MM	A60 R-BF	100	400
UK18016222	180 X 1.6 X 22.2 MM	A46 R-BF	50	200

**CUTTING DISC - STAINLESS STEEL
(DEPRESSED CENTER WHEELS)**



HIGHLIGHTS

- For ss material
- Superior resin bond
- Low vibration level

PART NO	DIMxTHx-HOLE(MM)	SPECIFICATION	M/S	CTN/ QTY
UK11510224	115X3.0X22.2	A30R - BF	50	200



GRINDING DISC - S.STEEL (DEPRESSED CENTER WHEELS FOR GRINDING)



HIGHLIGHTS

- For ss material
- Fast grinding
- Low vibration level

PART NO	DESCRIPTION	SPECIFICATION	PCS/ PKT	PCS/ CTN
UK1006017	4.5" X 6 MM	A24R - BF	25	100

**ALUMINIUM CUTTING WHEEL
(DEPRESSED CENTER WHEEL)**



HIGHLIGHTS

- Fast cutting
- Low vibration level
- Superior resin bond
- Comfortable working

PART NO	DESCRIPTION	SPECIFICATION	PCS/ PKT	PCS/ CTN
UK100X3	100 X 3.0 X 16 MM	A30 R-BF	50	200
UK115X3	115 X 3.0 X 22.2 MM	A30 R-BF	50	200
UK180X3	180 X 3.0 X 22.2	A30 R-BF	25	100

**ALUMINIUM GRINDING WHEEL
(DEPRESSED CENTER WHEEL)**



HIGHLIGHTS

- Fast & clean grinding
- Optimal material removal rate
- Superior resin bond
- Comfortable working

PART NO	DESCRIPTION	SPECIFICATION	PCS/ PKT	PCS/ CTN
UK100X6	100 X 6 X 16	A24R-BF	25	100
UK115X6	115 X 6.0 X 22.23	A24R-BF	25	100
UK180X6	180 X 6.0 X 22.23	A24R-BF	25	50

ALUMINIUM THIN CUTTING WHEELS

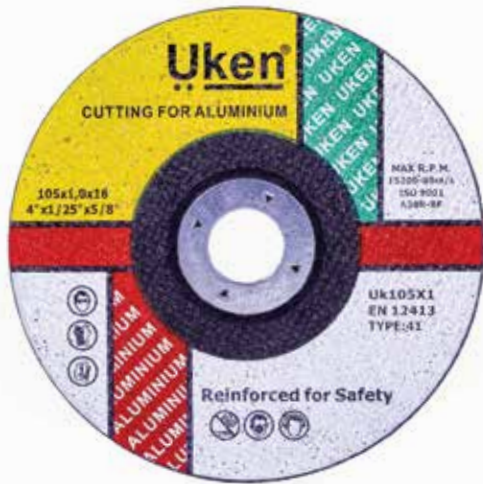

HIGHLIGHTS

- Fast cutting wheel reduce wastage of the work materials
- Higher cutting speed

PART NO	DESCRIPTION	SPECIFICATION	PCS/PKT	PCS/CTN
UK105X1	105 X 1.0 X 16 MM	A30 R -BF	100	400
UK115X1	115 X 1.0 X 22.2 MM	A60 R-BF	100	400
UK180X16	180 X 1.6 X 22.2 MM	A46 R -BF	50	200

CUTTING DISC / THIN WHEEL PREMIUM - INOX

HIGHLIGHTS

- Fast cutting
- Superior resin bond
- low vibration level
- Made in Germany



PART NO	DESCRIPTION	PCS/PKT
UG1151	115X1,0X22,23MM	50

FLAP DISCS



HIGHLIGHTS

- Weld blending, removing weldslag
- Deburring
- Edge blending and chamfering
- Surface Finishing
- For Use with Angle Grinder



PART NO	DESCRIPTION	SIZE	GRIT SIZE	PCS/PKT	PKT/CTN
U2202-4P60	TYPE 29 ANGLED	4"	60	10	20
U2202-4P80	TYPE 29 ANGLED	4"	80	10	20
U2202-4P100	TYPE 29 ANGLED	4"	100	10	20
U2202-4P120	TYPE 29 ANGLED	4"	120	10	20
U2202-4.5P60	TYPE 29 ANGLED	4.5"	60	10	20
U2202-4.5P80	TYPE 29 ANGLED	4.5"	80	10	20
U2202-4.5P100	TYPE 29 ANGLED	4.5"	100	10	20
U2202-4.5P120	TYPE 29 ANGLED	4.5"	120	10	20
U2202-7P60	TYPE 29 ANGLED	7"	60	10	10
U2202-7P80	TYPE 29 ANGLED	7"	80	10	10
U2202-7P100	TYPE 29 ANGLED	7"	100	10	10
U2202-7P120	TYPE 29 ANGLED	7"	120	10	10

WATER PROOF PAPER

Made with silicon carbide grains, these waterproof 9x11 sheets are high quality latex - backed paper. Used for light to heavy Sanding Shaping and finishing on material such as lacquers, paint, body fillers, glass, metal, stone and marble.

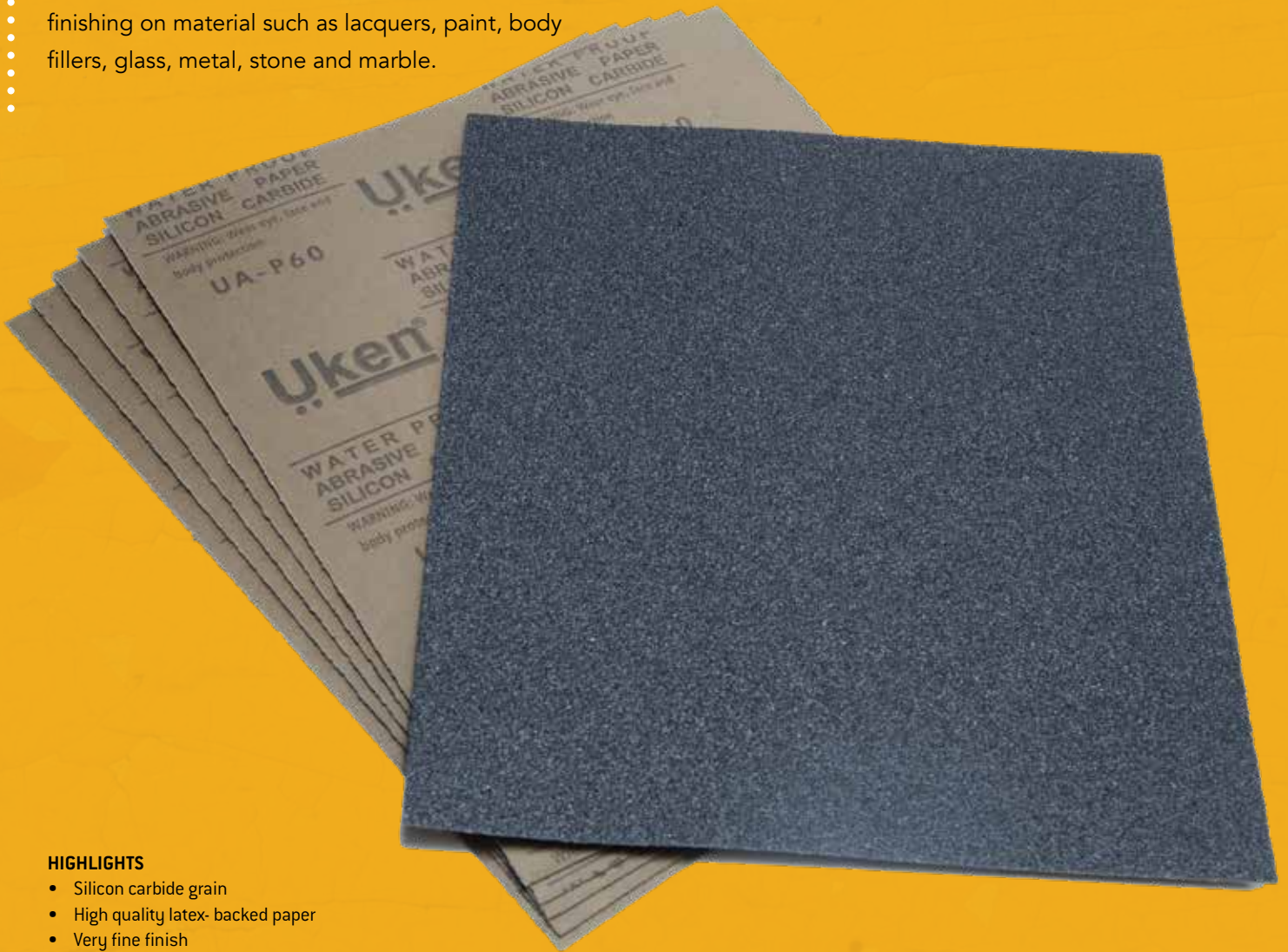

HIGHLIGHTS

- Silicon carbide grain
- High quality latex- backed paper
- Very fine finish
- Best When used with water or lubricant
- Widely used in Automotive market

PART NO	DESCRIPTION	GRIT SIZE	PCS/PKT	PCS/CTN
UA-P60	230 MM X 280 MM	60	50	20
UA-P80	230 MM X 280 MM	80	50	20
UA-P100	230 MM X 280 MM	100	50	20
UA-P120	230 MM X 280 MM	120	50	20
UA-P150	230 MM X 280 MM	150	50	20
UA-P180	230 MM X 280 MM	180	50	20
UA-P220	230 MM X 280 MM	220	50	20
UA-P240	230 MM X 280 MM	240	50	20

PART NO	DESCRIPTION	GRIT SIZE	PCS/PKT	PCS/CTN
UA-P320	230 MM X 280 MM	320	50	20
UA-P400	230 MM X 280 MM	400	50	20
UA-P600	230 MM X 280 MM	600	50	20
UA-P800	230 MM X 280 MM	800	50	20
UA-P1000	230 MM X 280 MM	1000	50	20
UA-P1200	230 MM X 280 MM	1200	50	20
UA-P1500	230 MM X 280 MM	1500	50	20
UA-P2000	230 MM X 280 MM	2000	50	20

CIRCULAR SAW BLADE WOOD - PROFESSIONAL

HIGHLIGHTS

- Precision ground teeth for smooth and accurate cuts
- Corrosion-resistant coating helps prevent rusting
- Hardened & Tempered steel body
- High welding strength
- Better performance at an economic price
- Heavy duty tungsten carbide tips maintain cutting edge for long blade life



PART NO.	BLADE DIA. (MM)	BLADE THICKNESS (MM)	BORE DIA. (MM)	BORE ADJUSTABLE DIA. (MM)	NO OF TEETH	APPLICATION	SUITABLE FOR
U71124	110	1.6	20	16	24	WOOD	CUTTING MEDIUM-SOFT WOODEN MATERIAL, ARTIFICIAL BOARD
U71140	110	1.6	20	16	40	WOOD	CUTTING MEDIUM-SOFT WOODEN MATERIAL, ARTIFICIAL BOARD
U71416	184	2.2	30	20	16	WOOD	CUTTING ALL KINDS OF SOFT WOOD
U71420	184	2.2	30	20	20	WOOD	CUTTING ALL KINDS OF SOFT WOOD
U71424	184	2.2	30	20	24	WOOD	CUTTING ALL KINDS OF SOFT WOOD
U71440	184	2.2	30	20	40	WOOD	CUTTING ALL KINDS OF SOFT WOOD
U71460	184	2.2	30	20	60	WOOD	CUTTING MEDIUM-SOFT WOODEN MATERIAL, ARTIFICIAL BOARD
U71524	235	2.8	30	25.4/25/16	24	WOOD	CUTTING ALL KINDS OF SOFT WOOD
U71540	235	2.8	30	25.4/25/16	40	WOOD	CUTTING MEDIUM-SOFT WOODEN MATERIAL, ARTIFICIAL BOARD
U71560	235	2.8	30	25.4/25/16	60	WOOD	CUTTING MEDIUM-SOFT WOODEN MATERIAL, ARTIFICIAL BOARD
U71580	235	2.8	30	25.4/25/16	80	WOOD	CUTTING MEDIUM-SOFT WOODEN MATERIAL, ARTIFICIAL BOARD
U715100	235	2.8	30	25.4/25/16	100	WOOD	CUTTING ALL KINDS OF SOFT WOOD AND HARD WOOD, MDF AND CHIPWOOD
U71760	305	3.2	30	25.4/25/15.88	60	WOOD	CUTTING MEDIUM-SOFT WOODEN MATERIAL, ARTIFICIAL BOARD
U71772	305	3.2	30	25.4/25/15.88	72	WOOD	CUTTING MEDIUM-SOFT WOODEN MATERIAL, ARTIFICIAL BOARD
U71796	305	3.2	30	25.4/25/15.88	96	WOOD	CUTTING ALL KINDS OF SOFT WOOD AND HARD WOOD, MDF AND CHIPWOOD
U717100	305	3.2	30	25.4/25/15.88	100	WOOD	CUTTING ALL KINDS OF SOFT WOOD AND HARD WOOD, MDF AND CHIPWOOD
U71860	355	3.2	30	25.4/25/15.88	60	WOOD	CUTTING MEDIUM-SOFT WOODEN MATERIAL, ARTIFICIAL BOARD
U71872	355	3.2	30	25.4/25/15.88	72	WOOD	CUTTING MEDIUM-SOFT WOODEN MATERIAL, ARTIFICIAL BOARD
U71896	355	3.2	30	25.4/25/15.88	96	WOOD	CUTTING ALL KINDS OF SOFT WOOD AND HARD WOOD, MDF AND CHIPWOOD
U71972	405	3.2	30	25.4/25/15.88	72	WOOD	CUTTING MEDIUM-SOFT WOODEN MATERIAL, ARTIFICIAL BOARD
U71980	405	3.2	30	25.4/25/15.88	80	WOOD	CUTTING MEDIUM-SOFT WOODEN MATERIAL, ARTIFICIAL BOARD

CIRCULAR SAW BLADE WOOD

HIGHLIGHTS

- Cross and rip cutting, wood, joinery, cabinet and carpending jobs
- Hardened and tempered steel
- Precision grand teeth for smooth and accurate cuts



PART NO.	BLADE DIA. (MM)	BLADE THICKNESS (MM)	BORE DIA. (MM)	BORE ADJUSTABLE DIA. (MM)	NO OF TEETH	APPLICATION	SUITABLE FOR
U4X30	110	1.8	20	16	30	WOOD	ALL KIND OF SOFT WOODS
U4X40	110	1.8	20	16	40	WOOD	MEDIUM-SOFT WOODEN MATERIALS, ARTIFICIAL BOARD
U4.5X30	115	1.8	20	16	30	WOOD	MEDIUM-SOFT WOODEN MATERIALS, ARTIFICIAL BOARD
U4.5X40	115	1.8	20	16	40	WOOD	MEDIUM-SOFT WOODEN MATERIALS, ARTIFICIAL BOARD
U5X30	125	1.8	20	16	30	WOOD	MEDIUM-SOFT WOODEN MATERIALS, ARTIFICIAL BOARD
U5X40	125	1.8	20	16	40	WOOD	MEDIUM-SOFT WOODEN MATERIALS, ARTIFICIAL BOARD
U7X24	180	2.2	30	25.4 / 20	24	WOOD	ALL KIND OF SOFT WOODS
U7X40	180	2.2	30	25.40 /20	40	WOOD	MEDIUM-SOFT WOODEN MATERIALS, ARTIFICIAL BOARD
U7X60	180	2.2	30	25.40 /20	60	WOOD	MEDIUM-SOFT WOODEN MATERIALS, ARTIFICIAL BOARD
U9X24	230	2.8	30	25.40 /20	24	WOOD	ALL KIND OF SOFT WOODS
U9X40	230	2.8	30	25.40 /20	40	WOOD	ALL KIND OF SOFT WOODS
U9X60	230	2.8	30	25.40 /20	60	WOOD	MEDIUM-SOFT WOODEN MATERIALS, ARTIFICIAL BOARD
U9X96	230	2.8	30	25.40 /20	96	WOOD	MEDIUM-SOFT WOODEN MATERIALS, MDF, CHIPWOOD &HARD WOODS
U10X60	254	2.8	35	25.40 /20	60	WOOD	ALL KIND OF SOFT WOODS
U10X80	254	2.8	35	25.40 /20	80	WOOD	ALL KIND OF SOFT WOODS & ARTIFICIAL BOARDS
U12X48	300	3.2	35	30/25.40	48	WOOD	MEDIUM-SOFT WOODEN MATERIALS, ARTIFICIAL BOARD
U12X60	300	3.2	35	30/25.40	60	WOOD	MEDIUM-SOFT WOODEN MATERIALS, ARTIFICIAL BOARD
U12X80	300	3.2	35	30/25.40	80	WOOD	MEDIUM-SOFT WOODEN MATERIALS, ARTIFICIAL BOARD
U12X96	300	3.2	35	30/25.40	96	WOOD	MEDIUM-SOFT WOODEN MATERIALS, ARTIFICIAL BOARD
U12X100	300	3.2	35	30/25.40	100	WOOD & PLASTIC	MEDIUM-SOFT WOODEN MATERIALS, MDF, CHIPWOOD &SOFT PLASTIC MATERIALS
U14X40	350	3.2	35	30/25.40	40	WOOD	ALL KIND OF SOFT WOODS
U14X60	350	3.2	35	30/25.40	60	WOOD	MEDIUM-SOFT WOODEN MATERIALS, ARTIFICIAL BOARD
U14X84	350	3.2	35	30/25.40	84	WOOD	MEDIUM-SOFT WOODEN MATERIALS, ARTIFICIAL BOARD
U14X100	350	3.2	35	30/25.40	100	WOOD & PLASTIC	MEDIUM-SOFT WOODEN MATERIALS, MDF, CHIPWOOD &SOFT PLASTIC MATERIALS
U16X60	400	3.2	35	30/25.40	60	WOOD	MEDIUM-SOFT WOODEN MATERIALS, ARTIFICIAL BOARD



CIRCULAR SAW BLADE ALUMINIUM CUTTING - PROFESSIONAL

HIGHLIGHTS

- Precision ground teeth for smooth and accurate cuts
- Corrosion-resistant coating helps prevent rusting
- Hardened & Tempered steel body
- High welding strength
- Better performance at an economic price
- Heavy duty tungsten carbide tips maintain cutting edge for long blade life

PART NO.	BLADE DIA. (MM)	BLADE THICKNESS (MM)	BORE DIA. (MM)	BORE ADJUSTABLE DIA. (MM)	NO OF TEETH	APPLICATION	SUITABLE FOR
U71448AL	184	2.5	30	20/16	48	ALUMINIUM	CUTTING ALL KINDS OF PROFILED ALUMINIUM
U71460AL	184	2.5	30	20/16	60	ALUMINIUM	CUTTING ALL KINDS OF PROFILED ALUMINIUM
U715100AL	235	2.5	30	25.4/25/16	100	ALUMINIUM	CUTTING THIN PROFILED ALUMINIUM (BELOW 3MM-THICKNESS)
U717100AL	305	3.2	30	25.4/25/15.88	100	ALUMINIUM	CUTTING ALL KINDS OF PROFILED ALUMINIUM (BELOW 5MM-THICKNESS)
U718100AL	355	3.2	30	25.4/25/15.88	100	ALUMINIUM	CUTTING ALL KINDS OF PROFILED ALUMINIUM

CIRCULAR SAW BLADE ALUMINIUM CUTTING

HIGHLIGHTS

- Precision ground teeth for smooth and accurate cuts
- Corrosion-resistant coating helps prevent rusting
- Hardened & Tempered steel body
- High welding strength
- Better performance at an economic price



PART NO.	BLADE DIA. (MM)	BLADE THICKNESS (MM)	BORE DIA. (MM)	BORE ADJUSTABLE DIA. (MM)	NO OF TEETH	APPLICATION	SUITABLE FOR
UA7X48	180	2.2	30	25.4 / 16	48	ALUMINIUM	ALL KINDS OF PROFILED ALUMINIUM
UA10X100	254	2.8	35	30/25.40	100	ALUMINIUM	THIN PROFILED ALUMINIUM BELOW 3MM.
UA12X96	300	3.2	35	30/25.40	96	ALUMINIUM	THIN PROFILED ALUMINIUM BELOW 5MM.
UA14X84	350	3.2	35	30/25.40	84	ALUMINIUM	ALL KINDS OF PROFILED ALUMINIUM

TILE CUTTING

HIGHLIGHTS

- Diamond wheel continuous rim type
- Suitable for ceramic parcel and marble

PART NO	DESCRIPTION	PCS / PKT	PCS / CTN
UT105T	100 MM	1	100
UT115T	115 MM	1	100
UT125T	125 MM	1	100
UT180T	180 MM	1	40 / 50
UT230T	230 MM	1	25



MARBLE/GRANITE CUTTING

HIGHLIGHTS

- Diamond wheel
- Segmented type



PART NO	DESCRIPTION	PCS / PKT	PCS / CTN
UM105M	100 MM	1	100
UM115M	115 MM	1	100
UM125M	125 MM	1	100
UM180M	180 MM	1	50
UM230M	230 MM	1	25



CONCRETE CUTTING - DRY

HIGHLIGHTS

- Diamond wheel
- Segmented type
- For concrete cutting - dry cutting

PART NO	DESCRIPTION	PCS/PKT	PCS/CTN
MC-105	100 MM	1	100
MC-115	115 MM	1	100
MC-125	125 MM	1	100
MC-180	180 MM	1	50
MC-230	230 MM	1	25
MC-300	300 MM	1	10
MC-350	350 MM	1	10

LASER WELDED DIAMOND SAW BLADE



HIGHLIGHTS

- Designed for cutting brick, block, concrete, stone and like material
- 4.5" 115mm segment height offers extended cutting life
- Laser welded segments ensure safety & durability
- Use Wet & Dry

PART NO	DESCRIPTION	PCS/PKT	PCS/CTN
UC115L	4.5"	1	100

CONCRETE CUTTING BLADE



HIGHLIGHTS

- Diamond wheel
- Segmented type
- For green concrete cement bricks

PART NO	DESCRIPTION	PCS / PKT	PCS / CTN
UC105C	100 MM	1	100
UC115C	115 MM	1	100
UC125C	125 MM	1	100
UC180C	180 MM	1	50
UC230C	230 MM	1	25

DIAMOND CUP GRINDING

HIGHLIGHTS

- Suitable for use on grinding on marble, tiles, concrete and rock.
- This aggressive turbo cup grinding wheel provides for very fast action



PART NO	DESCRIPTION	PCS / PKT	PCS / CTN
UCW100D	100 MM	1	20
UCW115D	115 MM	1	20
UCW125D	125 MM	1	20
UCW80C	80X2.5X20 MM	1	20

SPIRAL RAW DIAMOND CUP WHEEL

HIGHLIGHTS

- Turbo design for smooth Consistent finish
- Optimized hole pattern for fast dust removal
- Dust -Control use - ideal for use in evdery angle grinders
- Use Wet & Dry



PART NO	DESCRIPTION	PCS/PKT	PCS/CTN
UCT100D	4"	1	50

CUP WIRE BRUSH - CRIMPED

HIGHLIGHTS

- Ideal for flat surfaces
- Light rust removal
- For different models

PART NO	DESCRIPTION	PCS / PKT	PCS / CTN
U42104	M10 X 65 MM	1	100
U42105	M14 X 65 MM	1	100
U42106	M14 X 75 MM	1	100
U42107	M14 X100 MM	1	40



CUP WIRE BRUSH - TWISTED

HIGHLIGHTS

- Heavy duty for cleaning large material surface
- For rust & paint removal
- For different models

PART NO	DESCRIPTION	PCS / PKT	PCS / CTN
U42100	M10 X 65 MM	1	100
U42101	M14 X 65 MM	1	100
U42102	M14 X 75 MM	1	100
U42103	M14 X100 MM	1	40



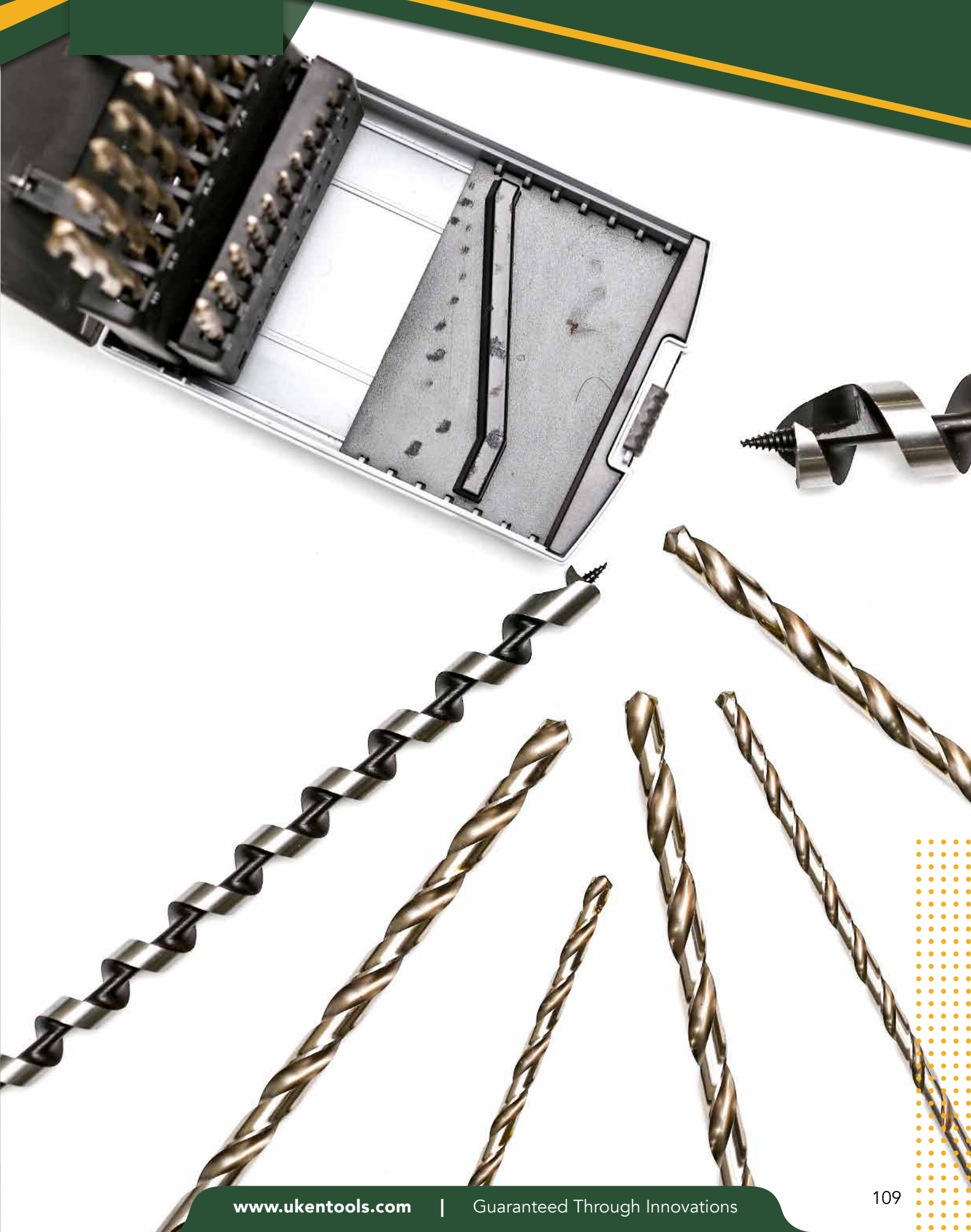

HSS DRILL BIT

HIGHLIGHTS

- Precision ground point drill bit for ferrous and non metals
- Providing a good drilling speed and long working life
- Available in different sizes

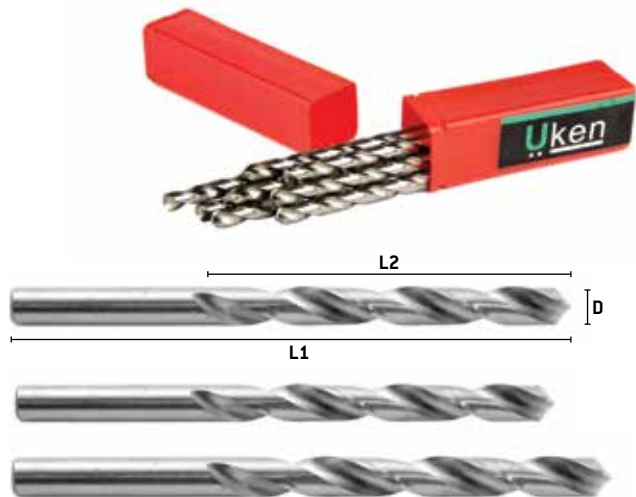

PART NO	DESCRIPTION D X L1 X L2	PCS/PKT	PCS/CTN
416001	1.0 X 34 X 12 MM	10	2000
416002	1.5 X 43 X 20 MM	10	3000
416010	2.0 X 49 X 24 MM	10	2000
416011	2.5 X 57 X 30 MM	10	3000
416012	3.0 X 61 X 33 MM	10	3000
416013	3.2 X 65 X 36 MM	10	3000
416014	3.5 X 70 X 39 MM	10	3000
416015	4.0 X 75 X 43 MM	10	1000
416016	4.2 X 75 X 43 MM	10	1000
416017	4.5 X 80 X 47 MM	10	1000
416018	5.0 X 86 X 52 MM	10	1000
416019	5.5 X 93 X 57 MM	10	1000
416020	6.0 X 93 X 57 MM	10	1000
416021	6.5 X 101 X 63 MM	10	1000
416022	7.0 X 109 X 69 MM	10	600
416023	7.5 X 109 X 69 MM	10	500
416024	8.0 X 117 X 75 MM	10	200
416025	8.5 X 117 X 75 MM	5	300
416026	9.0 X 125 X 81 MM	5	250 / 300
416027	9.5 X 125 X 81 MM	5	300
416003	10.0 X 133 X 87 MM	5	200
416004	10.5 X 133 X 87 MM	5	200
416005	11.0 X 142 X 94 MM	5	200
416006	11.5 X 142 X 94 MM	5	200
416007	12.0 X 151 X 101 MM	5	200
416008	12.5 X 151 X 101 MM	5	200
416009	13.0 X 151 X 101 MM	5	200

HSS STRAIGHT SHANK TWIST DRILL BIT - LONG SERIES

HIGHLIGHTS

- Fully ground - White finish
- 135 Split point angle - DIN 340
- Material HSS
- For ferrous and non-ferrous materials

PART NO	D&S (MM)	L1 (MM)	L2 (MM)	PCS/ PKT	PCS/ CTN
0516-1.0	1.0	56	33	10	300
0516-1.5	1.5	70	45	10	300
0516-2.0	2.0	85	56	10	1000
0516-2.5	2.5	95	62	10	500
0516-3.0	3.0	100	63	10	500
0516-3.2	3.2	106	69	10	500
0516-3.5	3.5	110	73	10	500
0516-4.0	4.0	119	78	10	500
0516-4.2	4.2	119	78	10	500
0516-4.5	4.5	126	82	10	500
0516-5.0	5.0	132	87	10	500
0516-5.5	5.5	139	91	10	500
0516-6.0	6.0	139	91	10	500
0516-6.5	6.5	148	97	10	500
0516-7.0	7.0	156	102	10	500
0516-7.5	7.5	156	102	10	500
0516-8.0	8.0	165	109	10	500
0516-8.5	8.5	165	109	5	500
0516-9.0	9.0	175	115	5	500
0516-9.5	9.5	175	115	5	200
0516-10.0	10.0	184	121	5	200
0516-10.5	10.5	184	121	5	200
0516-11.0	11.0	195	128	5	200
0516-11.5	11.5	195	128	5	150
0516-12.0	12.0	205	134	5	100
0516-12.5	12.5	205	134	5	200
0516-13.0	13.0	205	134	5	100

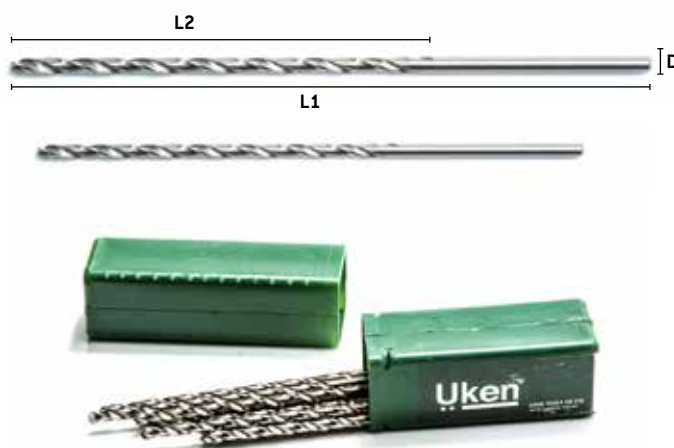

HSS STRAIGHT SHANK TWIST DRILL - EXTRA LONG SERIES

HIGHLIGHTS

- Fully ground - White finish
- 135 Split point angle - DIN 1869
- Material HSS
- For ferrous and non-ferrous materials



PART NO	D&S (MM)	L1 (MM)	L2 (MM)	PCS/ PKT	PCS/ CTN
0616-2.0	2.0	125	85	10	300
0616-2.5	2.5	140	95	10	300
0616-3.0	3.0	150	100	10	500
0616-3.5	3.5	165	115	10	600
0616-4.0	4.0	175	120	10	500
0616-4.5	4.5	185	125	10	600
0616-5.0	5.0	195	135	10	500
0616-5.5	5.5	205	140	10	500
0616-6.0	6.0	205	140	10	500
0616-6.5	6.5	215	150	10	200
0616-7.0	7.0	225	155	10	100
0616-7.5	7.5	225	155	10	200
0616-8.0	8.0	240	165	10	150
0616-8.5	8.5	240	165	5	100
0616-9.0	9.0	250	175	5	100
0616-9.5	9.5	250	175	5	100
0616-10.0	10.0	265	185	5	50
0616-10.5	10.5	265	185	5	50
0616-11.0	11.0	280	195	5	50
0616-11.5	11.5	280	195	5	50
0616-12.0	12.0	295	205	5	50
0616-12.5	12.5	295	205	5	50
0616-13.0	13.0	295	205	5	50

HSS REDUCED SHANK TWIST DRILL

HIGHLIGHTS

- Fully ground - White finish
- 135 Split point angle - DIN 338
- Material HSS
- For ferrous and non-ferrous materials



PART NO	D (MM)	L1 (MM)	L2 (MM)	S (MM)	PCS/ PKT	PCS/ CTN
0716-13.5	13.5	160	108	13	1	100
0716-14.0	14.0	160	108	13	1	100
0716-14.5	14.5	169	114	13	1	100
0716-15.0	15.0	169	114	13	1	50
0716-15.5	15.5	178	120	13	1	50
0716-16.0	16.0	178	120	13	1	50
0716-16.5	16.5	184	125	13	1	50
0716-17.0	17.0	184	125	13	1	50
0716-17.5	17.5	191	130	13	1	50
0716-18.0	18.0	191	130	13	1	50
0716-18.5	18.5	198	135	13	1	50
0716-19.0	19.0	198	135	13	1	50
0716-19.5	19.5	205	140	13	1	50
0716-20.0	20.0	205	140	13	1	50
0716-20.5	20.5	205	140	13	1	25
0716-21.0	21.0	205	145	13	1	25
0716-21.5	21.5	205	145	13	1	25
0716-22.0	22.0	210	150	13	1	25
0716-22.5	22.5	210	150	13	1	25
0716-23.0	23.0	215	155	13	1	25
0716-23.5	23.5	215	155	13	1	25
0716-24.0	24.0	220	160	13	1	25
0716-24.5	24.5	220	160	13	1	25
0716-25.0	25.0	220	160	13	1	25

TAPER SHANK DRILL BIT

HIGHLIGHTS

- HSS taper shank twist drill
- Standard DIN 345
- For drilling carbon steel, plastic and cast iron materials

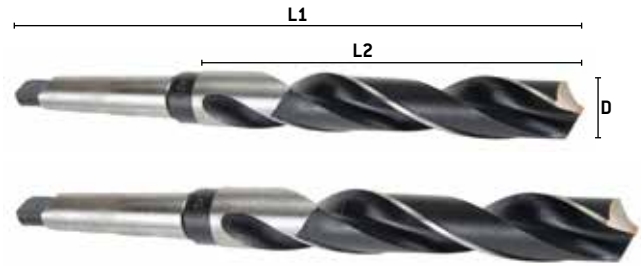

PART NO	DESCRIPTION D X L1 X L2	PCS/PKT	PCS/CTN
U44012	12 X 182 X 101 MM	1	50
U44125	12.50 X 182 X 101 MM	1	50
U44013	13 X 182 X 101 MM	1	50
U44135	13.5 X 189 X 108 MM	1	50
U44014	14 X 189 X 108 MM	1	50
U44145	14.5 X 212 X 114 MM	1	50
U44015	15 X 212 X 114 MM	1	50
U44155	15.5 X 218 X 120 MM	1	50
U44016	16 X 218 X 120 MM	1	50
U44165	16.5 X 223 X 125 MM	1	50
U44017	17 X 223 X 125 MM	1	50
U44175	17.5 X 228 X 130 MM	1	50
U44018	18 X 228 X 130 MM	1	50
U44185	18.5 X 233 X 135 MM	1	50
U44019	19 X 233 X 135 MM	1	50
U44195	19.5 X 238 X 140 MM	1	50
U44020	20 X 238 X 140 MM	1	50
U44205	20.5 X 243 X 145 MM	1	50
U44021	21 X 243 X 145 MM	1	50
U44215	21.5 X 248 X 150 MM	1	50
U44022	22 X 248 X 150 MM	1	30
U44225	22.5 X 253 X 155 MM	1	50
U44023	23 X 253 X 155 MM	1	50
U44235	23.5 X 276 X 155 MM	1	50

PART NO	DESCRIPTION D X L1 X L2	PCS/PKT	PCS/CTN
U44024	24 X 281 X 160 MM	1	25
U44245	24.5 X 281 X 160 MM	1	50
U44025	25 X 281 X 160 MM	1	25
U44255	25.5 X 286 X 165 MM	1	20
U44026	26 X 286 X 165 MM	1	20
U44265	26.5 X 286 X 165 MM	1	20
U44027	27 X 291 X 170 MM	1	20
U44275	27.5 X 291 X 170 MM	1	20
U44028	28 X 291 X 170 MM	1	20
U44285	28.5 X 296 X 175 MM	1	20
U44029	29 X 296 X 175 MM	1	20
U44295	29.5 X 296 X 175 MM	1	20
U44030	30 X 296 X 175 MM	1	20
U44031	31 X 301 X 180 MM	1	20
U44032	32 X 334 X 185 MM	1	20
U44033	33 X 334 X 185 MM	1	20
U44034	34 X 339 X 190 MM	1	20
U44035	35 X 339 X 190 MM	1	10
U44036	36 X 344 X 195 MM	1	10
U44037	37 X 344 X 195 MM	1	10
U44038	38 X 349 X 200 MM	1	10
U44039	39 X 349 X 200 MM	1	10
U44040	40 X 349 X 200 MM	1	10



HSS DRILL BIT SET



HIGHLIGHTS

- Precision ground point drill bit sets
- For ferrous and non-ferrous materials

PART NO	DESCRIPTION	PCS / PKT	PCS / CTN
U4301	HSS DRILL BIT SET 1-10MM (19 PCS - 1, 1.5, 2, 2.5, 3, 3.5, 4, 4.5, 5, 5.5, 6, 6.5, 7, 7.5, 8, 8.5, 9, 9.5, 10)	1	10

PART NO	DESCRIPTION	PCS / PKT	PCS / CTN
U4302	HSS DRILL BIT SET 1-13MM (25 PCS - 1, 1.5, 2, 2.5, 3, 3.5, 4, 4.5, 5, 5.5, 6, 6.5, 7, 7.5, 8, 8.5, 9, 9.5, 10, 10.5, 11, 11.5, 12, 12.5, 13)	1	10



SS DRILL BIT

HIGHLIGHTS

- Precision ground point ss drill bit for hardest materials
- Providing a good drilling speed and long working life
- Available different sizes
- 5% cobalt

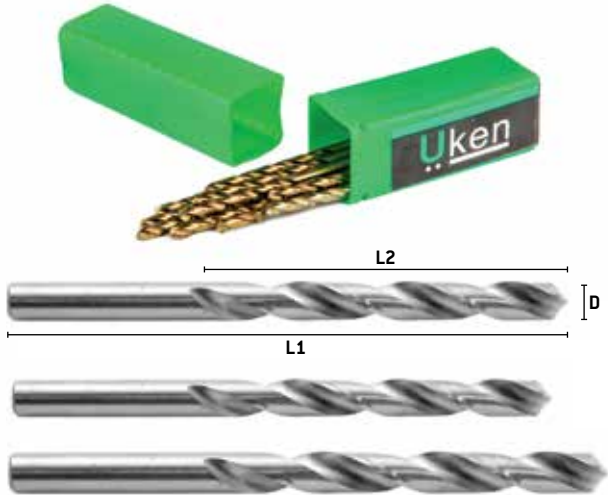

PART NO	DESCRIPTION D X L1 X L2	PCS/PKT	PCS/CTN
417001	1.0 X 34 X 12 MM	10	3000
417002	1.5 X 43 X 20 MM	10	3000
417010	2.0 X 49 X 24 MM	10	3000
417011	2.5 X 57 X 30 MM	10	3000
417012	3.0 X 61 X 33 MM	10	2000
417013	3.2 X 65 X 36 MM	10	2000
417014	3.5 X 70 X 39 MM	10	2000
417015	4.0 X 75 X 43 MM	10	1000
417016	4.2 X 75 X 43 MM	10	1000
417017	4.5 X 80 X 47 MM	10	1000
417018	5.0 X 86 X 52 MM	10	1000
417019	5.5 X 93 X 57 MM	10	1000
417020	6.0 X 93 X 57 MM	10	1000
417021	6.5 X 101 X 63 MM	10	500
417022	7.0 X 109 X 69 MM	10	500
417023	7.5 X 109 X 69 MM	10	500
417024	8.0 X 117 X 75 MM	10	400
417025	8.5 X 117 X 75 MM	5	250
417026	9.0 X 125 X 81 MM	5	300
417027	9.5 X 125 X 81 MM	5	250
417003	10.0 X 133 X 87 MM	5	200
417004	10.5 X 133 X 87 MM	5	200
417005	11.0 X 142 X 94 MM	5	200
417006	11.5 X 142 X 94 MM	5	200
417007	12.0 X 151 X 101 MM	5	200
417008	12.5 X 151 X 101 MM	5	200
417009	13.0 X 151 X 101 MM	5	200

WOOD DRILL BIT

HIGHLIGHTS

- Three point wood bit use for soft & medium woods.
- Polished body with centre points

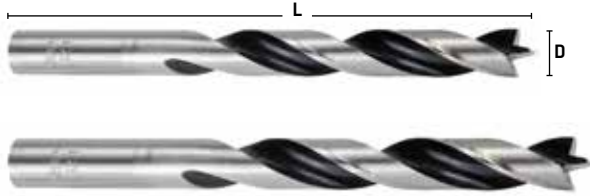

PART NO	DESCRIPTION (D X L)	PCS/PKT	PCS/CTN
U145	5 X 85 MM	50	500
U146	6 X 90 MM	50	200
U147	7 X 100 MM	50	200
U148	8 X 110 MM	50	200
U149	9 X 150 MM	50	200
U1410	10 X 120 MM	50	200
U1411	11 X 140 MM	50	200
U1412	12 X 140 MM	50	200
U1413	13 X 150 MM	25	50



AUGER DRILL BIT

HIGHLIGHTS

- Pointed for accurate drilling
- Provides clean holes with less splintering
- Easy to make the holes
- Available in different sizes

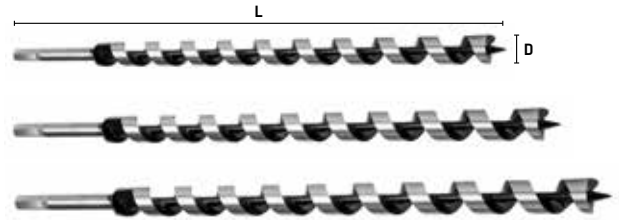

PART NO	DESCRIPTION (D X L)	PCS/PKT	PCS/CTN
U441620	16 X 200 MM	1	50
U441646	16 X 460 MM	1	25
U441660	16 X 600 MM	1	50
U441820	18 X 200 MM	1	50
U441846	18 X 460 MM	1	25
U441860	18 X 600 MM	1	25
U442020	20 X 200 MM	1	50
U442046	20 X 460 MM	1	50
U442060	20 X 600 MM	1	25
U442220	22 X 200 MM	1	50
U442246	22 X 460 MM	1	25
U442260	22 X 600 MM	1	25
U442420	24 X 200 MM	1	50
U442446	24 X 460 MM	1	25
U442460	24 X 600 MM	1	25
U442520	25 X 200 MM	1	50
U442546	25 X 460 MM	1	25
U442560	25 X 600 MM	1	10
U442620	26 X 200 MM	1	20
U442646	26 X 460 MM	1	10
U442660	26 X 600 MM	1	10
U442820	28 X 200 MM	1	50
U442846	28 X 460 MM	1	10
U442860	28 X 600 MM	1	10
U443020	30 X 200 MM	1	50
U443046	30 X 460 MM	1	10
U443060	30 X 600 MM	1	10
U443220	32 X 200 MM	1	20
U443246	32 X 460 MM	1	10
U443260	32 X 600 MM	1	10

MASONRY DRILL BIT

HIGHLIGHTS

- Used for drilling anchor, plastic plug, fixing and pipe work clearance holes.
- Suitable for masonry, brick / block work stones

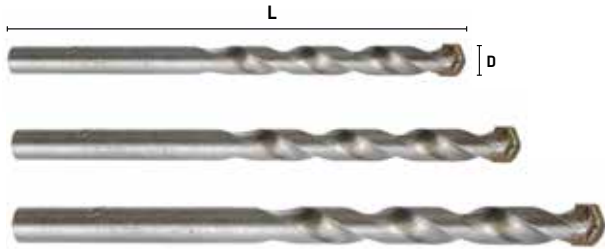

PART NO	DESCRIPTION (D X L)	PCS/PKT	PCS/CTN
U13360	3 X 60MM	100	500
U13475	4 X 75MM	100	500
U13585	5 X 85MM	100	500
U136100	6 X 100MM	100	500
U137100	7 X 100MM	50	200
U138120	8 X 120MM	50	200
U139120	9 X 120MM	50	200
U1310120	10 X 120MM	50	200
U1311150	11 X 150MM	50	200
U1312150	12 X 150MM	50	200
U1313150	13 X 150MM	25	50
U1314150	14 X 150MM	25	50
U1315150	15 X 150MM	25	50
U1316150	16 X 150MM	50	25



FLAT CHISEL SDS PLUS / POINT CHISEL SDS PLUS

HIGHLIGHTS

- For light chipping and chiselling of tiles, glazing compounds and other masonry works
- Specially toughened steel and controlled heat treatment ensure consistent tough bits with long life

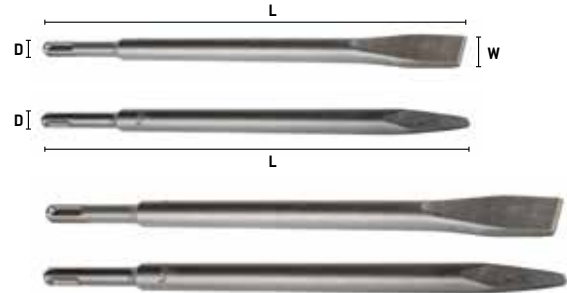

PART NO	DESCRIPTION	PCS/PKT	PCS/CTN
U10F14280	14 X 280 (D X L)	25	100
U10P14280	14 X 20 X 280 MM (D X W X L)	25	100

FLAT CHISEL SDS MAX / POINT CHISEL SDS MAX

HIGHLIGHTS

- For heavy duty application; chiselling and demolition and all masonry works
- Specially toughened steel and controlled heat treatment ensure consistent tough bits with long life

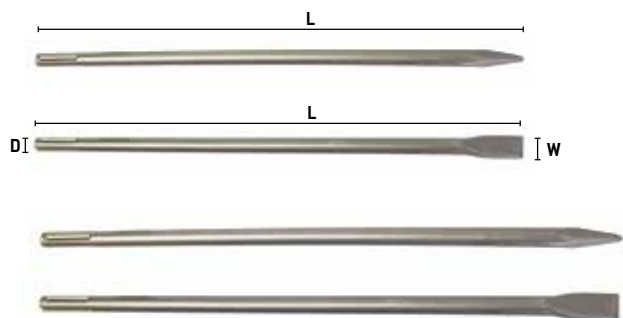

PART NO	DESCRIPTION	PCS/PKT	PCS/CTN
U12P18400	18 X 400 MM (D X L) POINTED	10	20
U12P18600	18 X 600 MM (D X L) POINTED	10	20
U12F18400	18 X 25 X 400 MM (D X W X L)	10	20
U12F18600	18 X 25 X 600MM (D X W X L)	10	20

SDS PLUS DRILL BIT

HIGHLIGHTS

- Suitable for masonry and concrete
- Optimized flutes offer fast drilling speed
- Superior carbide grade tip ensures out standing durability which gives consistent life

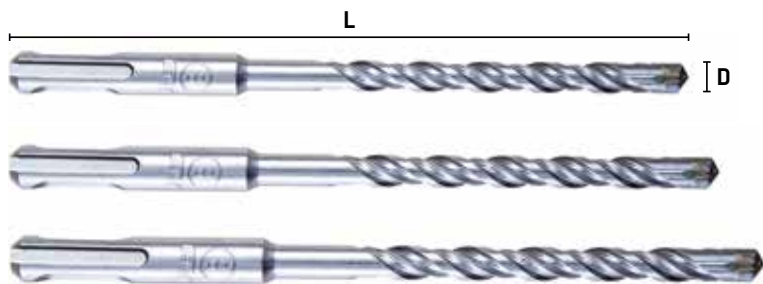

PART NO	DESCRIPTION (D X L)	PCS/PKT	PCS/CTN
U106110	6 X 110MM	50	200
U106160	6 X 160 MM	50	200
U106210	6 X 210 MM	50	200
U108110	8 X 110 MM	50	200
U108160	8 X 160 MM	50	200
U108210	8 X 210 MM	50	200
U108260	8 X 260 MM	50	100
U1010160	10 X 160 MM	50	200
U1010210	10 X 210 MM	50	200
U1010260	10 X 260 MM	50	100
U1010310	10 X 310 MM	50	100
U1012160	12 X 160 MM	50	200
U1012210	12 X 210 MM	50	200
U1012260	12 X 260 MM	50	100
U1012310	12 X 310 MM	50	100
U1014210	14 X 210 MM	50	50
U1014260	14 X 260 MM	25	50
U1014310	14 X 310 MM	25	50
U1016210	16 X 210 MM	25	100
U1016260	16 X 260 MM	25	50
U1016310	16 X 310 MM	25	50
U1018210	18 X 210 MM	25	50
U1018260	18 X 260 MM	25	50
U1018310	18 X 310 MM	25	50
U1018350	18 X 350 MM	25	50
U1020210	20 X 210 MM	25	50

PART NO	DESCRIPTION (D X L)	PCS/PKT	PCS/CTN
U1020260	20 X 260 MM	25	50
U1020310	20 X 310 MM	25	50
U1020350	20 X 350 MM	25	50
U1020400	20 X 400 MM	25	50
U1020450	20 X 450 MM	10	20
U1022260	22 X 260 MM	25	50
U1022310	22 X 310 MM	25	50
U1022350	22 X 350 MM	10	20
U1022400	22 X 400 MM	10	20
U1022450	22 X 450 MM	10	20
U1024260	24 X 260 MM	25	50
U1024310	24 X 310 MM	25	50
U1024350	24 X 350 MM	10	20
U1024400	24 X 400 MM	10	20
U1024450	24 X 450 MM	10	20
U1025260	25 X 260 MM	10	20
U1025310	25 X 310 MM	20	40
U1025350	25 X 350 MM	10	20
U1025400	25 X 400 MM	10	20
U1025450	25 X 450 MM	5	10
U1026260	26 X 260 MM	10	20
U1026310	26 X 310 MM	10	20
U1026350	26 X 350 MM	10	20
U1026400	26 X 400 MM	10	20
U1026450	26 X 450 MM	5	10

ROUTER BIT V GROOVING

HIGHLIGHTS

- For cutting V grooves in wood & MDF for decorative panel finishes
- Two cutting flutes for superior finish
- A special heat treating process to provide precision and durability

PART NO	DESCRIPTION S X D X BL	PCS/PKT	PCS/CTN
U24720	6 X 9.5 X 9.5 MM	1	30
U24796	6 X 12.7 X 12.7 MM	1	30
U24814	6 X 19.05 X 15.9 MM	1	30
U24826	8 X 9.5 X 12.7 MM	1	30

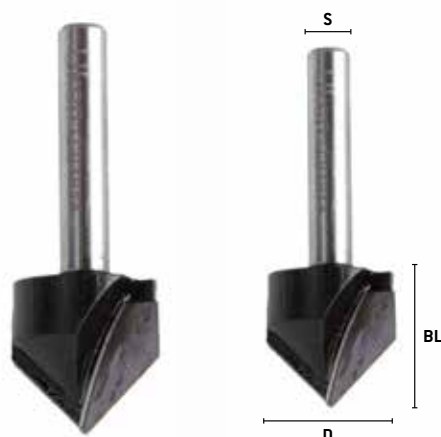

ROUTER BIT STRAIGHT

HIGHLIGHTS

- A special heat-treating process to provide precision and durability
- For general cutting of straight edges, hardwoods, MDF, plywood and chip board
- Can be used for straight trimming of laminates
- Available in different sizes

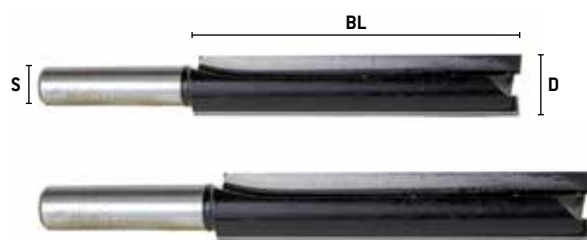

PART NO	DESCRIPTION S X D X BL	PCS/PKT	PCS/CTN
U24228	6 X 2 X 8 MM	1	30
U24272	6 X 3 X 12 MM	1	30
U24240	6 X 3 X 8 MM	1	30
U24316	6 X 3.97 X 12.7 MM	1	30
U24328	6 X 4 X 12 MM	1	30
U24372	6 X 5 X 20 MM	1	30
U26830	6 X 6 X 16 MM	1	30
U27254	6 X 6 X 16 MM	1	30
U27820	6 X 6 X 18.2 MM	1	30
U27266	6 X 6 X 19 MM	1	30
U24384	6 X 6 X 20 MM	1	30
U27004	6 X 6 X 25.4 MM	1	30
U27298	6 X 6 X 25.4 MM	1	30
U27310	6 X 8 X 20 MM	1	30
U27036	6 X 8 X 25 MM	1	30
U27354	6 X 10 X 25 MM	1	30
U27366	6 X 12 X 25.4 MM	1	30
U27484	6 X 20 X 20 MM	1	30

PART NO	DESCRIPTION S X D X BL	PCS/PKT	PCS/CTN
U27398	8 X 8 X 25 MM	1	30
U27048	8 X 12 X 38.1 MM	1	30
U27060	8 X 12 X 50.8 MM	1	30
U27092	8 X 12 X 63.5 MM	1	30
U27148	8 X 14 X 20 MM	1	30
U27416	8 X 14 X 30.5 MM	1	30
U27428	12 X 10 X 25 MM	1	30
U26842	12 X 10 X 30.5 MM	1	30
U27160	12 X 12 X 20 MM	1	30
U26874	12 X 12 X 25.4 MM	1	30
U27192	12 X 12 X 38.1 MM	1	30
U26886	12 X 12 X 38.1 MM	1	30
U26918	12 X 12 X 50.8 MM	1	30
U26930	12 X 12 X 63.5 MM	1	30
U26974	12 X 13 X 25 MM	1	30
U26986	12 X 14 X 20 MM	1	30
U27210	12 X 14 X 30.5 MM	1	30
U27472	12 X 25.4X25.4 MM	1	30



ROUTER BIT FLUSH TRIM

HIGHLIGHTS

- A special heat-treating process to provide precision and durability
- Suitable for trimming wood and plywoods
- Ball bearing will support smooth moments and fine cutting

PART NO	DESCRIPTION S X D X BL	PCS/PKT	PCS/CTN
U24478	6 X 9.5 X 25.4 MM	1	30
U27864	6 X 10 X 20 MM	1	30
U24490	6 X 12.7 X 25.4 MM	1	30
U24502	8 X 9.5 X 12.7 MM	1	30
U24534	8 X 12.7 X 30.2 MM	1	30
U-21012	12 X 12.7 X 30.2 MM	1	30
U24620	8 X 12 X 25 MM	1	30
U24446	6 X 6.35X 19 MM	1	30



GLASS DRILL BIT

HIGHLIGHTS

- Design for drilling glass, bottles, procelain, ceramics, use with drill stand only with cooling oil.

PART NO	DESCRIPTION	PCS / PKT	PCS / CTN
U1460	3MM	10	400
U1462	4MM	10	400
U1464	5MM	10	400
U1466	6MM	10	400
U1467	6.5MM	10	400
U1468	7MM	10	400
U1470	8MM	10	400
U1472	9MM	10	400
U1474	10MM	10	400
U1478	12MM	10	400
U1480	13MM	10	400

FLAT WOOD DRILL BIT

HIGHLIGHTS

- Manufactured from high grade carbon steel, drop forged, grounded
- 1/4" quick shank
- Heavy duty design for soft european hard wood, plasticboard etc



PART NO	DESCRIPTION	PCS / PKT	PCS / CTN
U1420	6MM	10	200
U1422	8MM	10	200
U1424	10MM	10	200
U1426	12MM	10	200
U1427	13MM	10	200
U1428	14MM	10	200
U1429	15MM	10	200
U1430	16MM	10	200
U1431	17MM	10	200
U1432	18MM	10	200
U1434	20MM	10	200
U1436	22MM	10	200
U1437	23MM	10	200
U1438	24MM	10	200
U1439	25MM	10	200
U1440	26MM	10	200
U1442	28MM	10	200
U1444	30MM	10	200
U1446	32MM	10	200
U1449	35MM	10	200
U1450	36MM	10	200
U1452	36MM	10	200
U1454	40MM	10	200



CARBIDE TIPPED HOLESAW

HIGHLIGHTS

- High quality Carbide tipped holesaw
- Assembled with high quality center Drill and Spring

Application

- Used for stainless steel product

PART NO	DESCRIPTION	PCS / PKT	PCS / CTN
U8216	16MM	1	-
U8218	18MM	1	-
U8219	19MM	1	-
U8220	20MM	1	-
U8222	22MM	1	-
U8225	25MM	1	-
U8226	26MM	1	-
U8227	27MM	1	-
U8228	28MM	1	-
U8229	29MM	1	-
U8230	30MM	1	-
U8232	32MM	1	-
U8235	35MM	1	-
U8238	38MM	1	-
U8240	40MM	1	-
U8242	42MM	1	-
U8245	45MM	1	-
U8248	48MM	1	-
U8250	50MM	1	-
U8251	51MM	1	-
U8255	55MM	1	-
U8258	58MM	1	-
U8260	60MM	1	-
U8264	64MM	1	-
U8270	70MM	1	-
U8275	75MM	1	-
U8276	76MM	1	-
U8280	80MM	1	-
U8285	85MM	1	-
U8290	90MM	1	-
U8295	95MM	1	-
U82100	100MM	1	-
U82105	105MM	1	-
U82110	110MM	1	-
U82120	120MM	1	-
U82127	127MM	1	-



PILOT DRILL BIT WITH SPRING

PART NO	DESCRIPTION	PCS / PKT	PCS / CTN
U8214	-	-	-

HOLE SAW

HIGHLIGHTS

- All purpose saws with HSS bi-metal



PART NO	DIA [MM]	DIA [INCH]
U8014	14	9/16"
U8016	16	5/8"
U8017	17	11/16"
U8019	19	3/4"
U8020	20	25/32"
U8021	21	13/16"
U8022	22	7/8"
U8024	24	15/16"
U8025	25	1"
U8027	27	1-1/16"
U8029	29	1-1/8"
U8030	30	1-3/16"
U8032	32	1-1/4"
U8033	33	1-5/16"
U8035	35	1-3/8"
U8037	37	1-7/16"
U8038	38	1-1/2"
U8040	40	1-9/16"
U8041	41	1-5/8"
U8043	43	1-11/16"
U8044	44	1-3/4"
U8046	46	1-13/16"
U8048	48	1-7/8"
U8051	51	2"
U8052	52	2-1/16"
U8054	54	2-1/8"
U8057	57	2-1/4"

PART NO	DIA [MM]	DIA [INCH]
U8059	59	2-5/16"
U8060	60	2-3/8"
U8064	64	2-1/2"
U8065	65	2-9/16"
U8067	67	2-5/8"
U8068	68	2-11/16"
U8070	70	2-3/4"
U8073	73	2-7/8"
U8076	76	3"
U8079	79	3-1/8"
U8083	83	3-1/4"
U8086	86	3-3/8"
U8089	89	3-1/2"
U8092	92	3-5/8"
U8095	95	3-3/4"
U8098	98	3-7/8"
U8102	102	4"
U8105	105	4-1/8"
U8108	108	4-1/4"
U8111	111	4-3/8"
U8114	114	4-1/2"
U8121	121	4-3/4"
U8127	127	5"
U8152	152	6"
U8177	177	6-31/32"
U8210	210	8-9/32"

BI-METAL HOLE SAW ARBOR



PART NO	DESCRIPTION
U80A1	A1- 3/8" HEX FOR 14-30MM
U80A2	A2 -1/4" ROUND FOR 14-30MM
U80A4	A4-3/8" HEX FOR 32-210MM
U80A10	A10-7/16" HEX FOR 32-210MM

HOLE SAW SET



PART NO	DESCRIPTION
U8000	16 20 25 32 38 51MM, 3/8HEX, 7/16" HEX
U8001	19 22 29 38 44 57MM 3/8HEX 7/16" HEX



COVERALL 100% COTTON - BEIGE



HIGHLIGHTS

- 100% Super fine cotton fabric
- Style: 2 chest pocket, Long sleeves, 2 side cross pocket, 2 back hip pocket, one pen pocket on sleeve
- Elasticized waist belt of back side

PART NO	DESCRIPTION	PCS / PKT	PCS / CTN
513003	SMALL	1	25
513002	MEDIUM	1	25
513001	LARGE	1	25
513004	XL	1	25
513005	XXL	1	25
513006	XXXL	1	25

COVERALL 100% COTTON - RED



HIGHLIGHTS

- 100% Super fine cotton fabric
- Style: 2 chest pocket, Long sleeves, 2 side cross pocket, 2 back hip pocket, one pen pocket on sleeve
- Elasticized waist belt of back side

PART NO	DESCRIPTION	PCS / PKT	PCS / CTN
513021	SMALL	1	25
513020	MEDIUM	1	25
513019	LARGE	1	25
513022	XL	1	25
513023	XXL	1	25
513024	XXXL	1	25

COVERALL 100% COTTON - DARKBLUE



HIGHLIGHTS

- 100% Super fine cotton fabric
- Style: 2 chest pocket, Long sleeves, 2 side cross pocket, 2 back hip pocket, one pen pocket on sleeve
- Elasticized waist belt of back side

PART NO	DESCRIPTION	PCS / PKT	PCS / CTN
513009	SMALL	1	25
513008	MEDIUM	1	25
513007	LARGE	1	25
513010	XL	1	25
513011	XXL	1	25
513012	XXXL	1	25

COVERALL 100% COTTON - LIGHTBLUE



HIGHLIGHTS

- 100% Super fine cotton fabric
- Style: 2 chest pocket, Long sleeves, 2 side cross pocket, 2 back hip pocket, one pen pocket on sleeve
- Elasticized waist belt of back side

PART NO	DESCRIPTION	PCS / PKT	PCS / CTN
513015	SMALL	1	25
513014	MEDIUM	1	25
351301	LARGE	1	25
513016	XL	1	25
513017	XXL	1	25
513018	XXXL	1	25

**COVERALL POLYSTER 65% /
COTTON 35% – BEIGE**



HIGHLIGHTS

- 65% Polyester and 35% cotton materials
- Style: 2 chest pocket, Long sleeves, 2 side cross pocket, 2 back hip pocket, one pen pocket on sleeve
- Elasticized waist belt of back side

PART NO	DESCRIPTION	PCS / PKT	PCS / CTN
513027	SMALL	1	25
513026	MEDIUM	1	25
513025	LARGE	1	25
513028	XL	1	25
513029	XXL	1	25
513030	XXXL	1	25



**COVERALL POLYSTER 65% /
COTTON 35% – DARKBLUE**

HIGHLIGHTS

- 65% Polyester and 35% cotton materials
- Style: 2 chest pocket, Long sleeves, 2 side cross pocket, 2 back hip pocket, one pen pocket on sleeve
- Elasticized waist belt of back side

PART NO	DESCRIPTION	PCS / PKT	PCS / CTN
513033	SMALL	1	25
513032	MEDIUM	1	25
513031	LARGE	1	25
513034	XL	1	25
513035	XXL	1	25
513036	XXXL	1	25

**COVERALL POLYSTER 65% /
COTTON 35% – LIGHTBLUE**



HIGHLIGHTS

- 65% Polyester and 35% cotton materials
- Style: 2 chest pocket, Long sleeves, 2 side cross pocket, 2 back hip pocket, one pen pocket on sleeve
- Elasticized waist belt of back side

PART NO	DESCRIPTION	PCS / PKT	PCS / CTN
513045	SMALL	1	25
513044	MEDIUM	1	25
513043	LARGE	1	25
513046	XL	1	25
513047	XXL	1	25
513048	XXXL	1	25

**COVERALL POLYSTER 65% /
COTTON 35% – RED**



HIGHLIGHTS

- 65% Polyester and 35% cotton materials
- Style: 2 chest pocket, Long sleeves, 2 side cross pocket, 2 back hip pocket, one pen pocket on sleeve
- Elasticized waist belt of back side

PART NO	DESCRIPTION	PCS / PKT	PCS / CTN
513051	SMALL	1	25
513050	MEDIUM	1	25
513049	LARGE	1	25
513052	XL	1	25
513053	XXL	1	25
513054	XXXL	1	25

**COVERALL POLYSTER 65%
COTTON 35% – GREEN**



HIGHLIGHTS

- 65% Polyester and 35% cotton materials
- Style: 2 chest pocket, Long sleeves, 2 side cross pocket, 2 back hip pocket, one pen pocket on sleeve
- Elasticized waist belt of back side

PART NO	DESCRIPTION	PCS / PKT	PCS / CTN
513039	SMALL	1	25
513038	MEDIUM	1	25
513037	LARGE	1	25
513040	XL	1	25
513041	XXL	1	25
513042	XXXL	1	25

**COVERALL POLYSTER 65% /
COTTON 35% – YELLOW**



HIGHLIGHTS

- 65% Polyester and 35% cotton materials
- Style: 2 chest pocket, Long sleeves, 2 side cross pocket, 2 back hip pocket, one pen pocket on sleeve
- Elasticized waist belt of back side

PART NO	DESCRIPTION	PCS / PKT	PCS / CTN
513057	SMALL	1	25
513056	MEDIUM	1	25
513055	LARGE	1	25
513058	XL	1	25
513059	XXL	1	25
513060	XXXL	1	25

PANT SHIRT 100% COTTON - BEIGE



HIGHLIGHTS

- 100% Superfine cotton .
- Style: Shirt - 2 chest Pocket
- Long sleeves with cuff
- Pant - 2 side cross pocket, 2 back hip pocket
- Elasticized waist at back side

PART NO	DESCRIPTION	PCS / PKT	PCS / CTN
U6320	SMALL	1	25
U6321	MEDIUM	1	25
U6322	LARGE	1	25
U6323	XL	1	25
U6324	XXL	1	25
U6325	XXXL	1	25

PANT SHIRT 100% COTTON - LIGHT BLUE



HIGHLIGHTS

- 100% Superfine cotton .
- Style: Shirt - 2 chest Pocket
- Long sleeves with cuff
- Pant - 2 side cross pocket, 2 back hip pocket
- Elasticized waist at back side

PART NO	DESCRIPTION	PCS / PKT	PCS / CTN
UPS100CS	SMALL	1	25
UPS100CM	MEDIUM	1	25
UPS100CL	LARGE	1	25
UPS100CXL	XL	1	25
UPS100CXXL	XXL	1	25
UPS100CXXXL	XXXL	1	25

PANT SHIRT 100% COTTON - DARK BLUE



HIGHLIGHTS

- 100% Superfine cotton
- Style: Shirt - 2 chest Pocket
- Long sleeves with cuff
- Pant - 2 side cross pocket, 2 back hip pocket
- Elasticized waist at back side

PART NO	DESCRIPTION	PCS / PKT	PCS / CTN
UPS100CDBS	SMALL	1	25
UPS100CDBM	MEDIUM	1	25
UPS100CDBL	LARGE	1	25
UPS100CDBXL	XL	1	25
UPS100CDBXXL	XXL	1	25
UPS100CDBXXXL	XXXL	1	25

PANT SHIRT 100% COTTON - RED



HIGHLIGHTS

- 100% Superfine cotton
- Style: Shirt - 2 chest
- Long sleeves with cuff
- Pant - 2 side cross pocket, 2 back hip pocket
- Elasticized waist at back side

PART NO	DESCRIPTION	PCS / PKT	PCS / CTN
UPS100CRS	SMALL	1	25
UPS100CRM	MEDIUM	1	25
UPS100CRL	LARGE	1	25
UPS100CRXL	XL	1	25
UPS100CRXXL	XXL	1	25
UPS100CRXXXL	XXXL	1	25

PANT SHIRT POLYSTER 65% / COTTON 35% - LIGHT BLUE

HIGHLIGHTS

- 65% Polyester & 35% cotton
- Style: Shirt - 2 chest Pocket
- Long sleeves with cuff
- Pant - 2 side cross pocket, 2 back hip pocket
- Elasticized waist at back side



PART NO	DESCRIPTION	PCS / PKT	PCS / CTN
UPS65/35LBS	SMALL	1	25
UPS65/35LBM	MEDIUM	1	25
UPS65/35LBL	LARGE	1	25
UPS65/35LBXL	XL	1	25
UPS65/35LBXXL	XXL	1	25
UPS65/35LBXXXL	XXXL	1	25

PANT SHIRT POLYSTER 65% / COTTON 35% - BEIGE



HIGHLIGHTS

- 65% Polyester & 35% cotton
- Style: Shirt - 2 chest Pocket
- Long sleeves with cuff
- Pant - 2 side cross pocket, 2 back hip pocket
- Elasticized waist at back side

PART NO	DESCRIPTION	PCS / PKT	PCS / CTN
U6326	SMALL	1	25
U6327	MEDIUM	1	25
U6328	LARGE	1	25
U6329	XL	1	25
U6330	XXL	1	25
U6331	XXXL	1	25

PANT SHIRT POLYSTER 65% / COTTON 35% - GREEN

HIGHLIGHTS

- 65% Polyester & 35% cotton
- Style: Shirt - 2 chest Pocket
- Long sleeves with cuff
- Pant - 2 side cross pocket, 2 back hip pocket
- Elasticized waist at back side



PART NO	DESCRIPTION	PCS / PKT	PCS / CTN
UPS65/35GS	SMALL	1	25
UPS65/35GM	MEDIUM	1	25
UPS65/35GL	LARGE	1	25
UPS65/35GXL	XL	1	25
UPS65/35GXXL	XXL	1	25
UPS65/35GXXXL	XXXL	1	25

PANT SHIRT POLYSTER 65% / COTTON 35% - RED

HIGHLIGHTS

- 65% Polyester & 35% cotton
- Style: Shirt - 2 chest Pocket
- Long sleeves with cuff
- Pant - 2 side cross pocket, 2 back hip pocket
- Elasticized waist at back side



PART NO	DESCRIPTION	PCS / PKT	PCS / CTN
UPS65/35RS	SMALL	1	25
UPS65/35RM	MEDIUM	1	25
UPS65/35RL	LARGE	1	25
UPS65/35RXL	XL	1	25
UPS65/35RXXL	XXL	1	25
UPS65/35RXXXL	XXXL	1	25



DISPOSABLE COVERALL

HIGHLIGHTS

- Body protection disposal
- Coverall with hood white, boot cover and elastic cuff

PART NO	DESCRIPTION	PCS / PKT	PCS / CTN
212002	MEDIUM	1	50
212001	LARGE	1	50
212003	XL	1	50
212004	XXL	1	50





SAFETY JACKET - GREEN FABRIC

HIGHLIGHTS

- Fabric type
- High visibility
- 2" tape (double side)
- Available in different sizes

PART NO	DESCRIPTION	PCS / PKT	PCS / CTN
UJ2601	SMALL	1	100
UJ2601M	MEDIUM	1	100
UJ2601L	LARGE	1	100
UJ2601XL	XL	1	100
UJ2601XXL	XXL	1	100
UJ2601XXXL	XXXL	1	100



SAFETY JACKET - GREEN MESH / NET



HIGHLIGHTS

- Mesh /Net type
- High visibility
- 1" reflect tape
- Available in different sizes

PART NO	DESCRIPTION	PCS / PKT	PCS / CTN
UJ2602	SMALL	1	200
UJ2602M	MEDIUM	1	200
UJ2602L	LARGE	1	200
UJ2602XL	XL	1	200
UJ2602XXL	XXL	1	200
UJ2602XXXL	XXXL	1	200

SAFETY JACKET GREEN MESH - 2" - REFLECTOR



HIGHLIGHTS

- Mesh/net type with reflector
- High visibility
- 2" reflector tape. (double side)
- Available different sizes

PART NO	DESCRIPTION	PCS / PKT	PCS / CTN
UJ2603	SMALL	1	200
UJ2603M	MEDIUM	1	200
UJ2603L	LARGE	1	200
UJ2603XL	XL	1	200
UJ2603XXL	XXL	1	200
UJ2603XXXL	XXXL	1	200

SAFETY JACKET - ORANGE FABRIC



HIGHLIGHTS

- Fabric type
- High visibility
- 2" tape (double side)
- Available in different sizes

PART NO	DESCRIPTION	PCS / PKT	PCS / CTN
UJ2701	SMALL	1	100
UJ2701M	MEDIUM	1	100
UJ2701L	LARGE	1	100
UJ2701XL	XL	1	100
UJ2701XXL	XXL	1	100
UJ2701XXXL	XXXL	1	100

SAFETY JACKET - ORANGE MESH



HIGHLIGHTS

- Mesh /Net type
- High visibility
- 1" reflect tape
- Available in different sizes

PART NO	DESCRIPTION	PCS / PKT	PCS / CTN
UJ2702	SMALL	1	200
UJ2702M	MEDIUM	1	200
UJ2702L	LARGE	1	200
UJ2702XL	XL	1	200
UJ2702XXL	XXL	1	200
UJ2702XXXL	XXXL	1	200

SAFETY JACKET ORANGE MESH - 2" - REFLECTOR



HIGHLIGHTS

- Mesh/net type with reflector
- High visibility
- 2" reflect tape. (double side)
- Available in different sizes

PART NO	DESCRIPTION	PCS / PKT	PCS / CTN
UJ2703	SMALL	1	200
UJ2703M	MEDIUM	1	200
UJ2703L	LARGE	1	200
UJ2703XL	XL	1	200
UJ2703XXL	XXL	1	200
UJ2703XXXL	XXXL	1	200

SAFETY FENCING

HIGHLIGHTS

- UV stabilized
- High strength
- High visibility
- Soft and portability
- Anti-corrosion

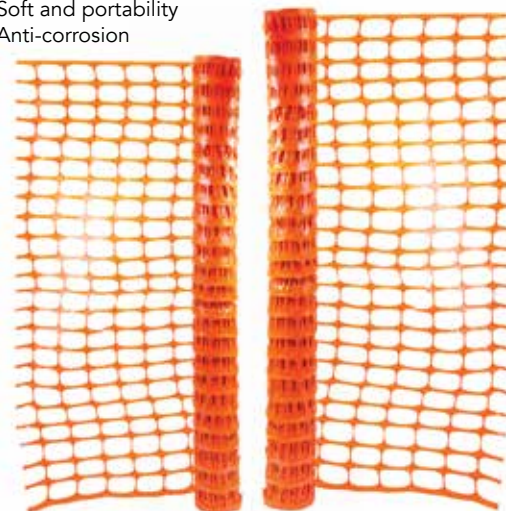

PART NO	DESCRIPTION	PCS / PKT	PCS / CTN
U6311	25 YARD VIRGIN	1	1

RAIN COAT



HIGHLIGHTS

- Light weight
- Coat has vented capback, 2 front pockets with flap
- High shine finish yellow color

PART NO	DESCRIPTION	PCS / PKT	PCS / CTN
U4700	SMALL	1	25
U4701	MEDIUM	1	25
U4702	LARGE	1	25
U4703	XL	1	25
U4704	XXL	1	25
U4705	XXXL	1	25

RAIN SUIT



HIGHLIGHTS

- Light weight
- Coat has vented capback, 2 front pockets with flap
- High shine finish yellow color

PART NO	DESCRIPTION	PCS / PKT	PCS / CTN
U4710	SMALL	1	20
U4711	MEDIUM	1	20
U4712	LARGE	1	20
U4713	XL	1	20
U4714	XXL	1	20
U4715	XXXL	1	20

SAFETY HELMET



HIGHLIGHTS

- High-density polyethylene
- Head cover is made with a durable injection molded
- 6 point plastic pinlock suspension, suspension assembled with shell packed, size adjustable type

PART NO	DESCRIPTION	PCS / PKT	PCS / CTN
U6300	YELLOW	1	40
U6301	LIGHT BLUE	1	40
U6302	DARK BLUE	1	40
U6303	WHITE	1	40
U6304	RED	1	40
U6310	GREEN	1	40

ROAD LIGHT WITH SINGLE BATTERY



HIGHLIGHTS

- 2pcs Super bright LED / Material PS Amber Lens
- Power: 4r25 6 Volt Battery/Blink Frequency 70 +-5 time/min
- Inside switch with photosenser make the light dusk and dawn off

PART NO	PCS / PKT	PCS / CTN
U6312	1	10

ROAD LIGHT - DOUBLE WITH & WITHOUT BRACKET



HIGHLIGHTS

- 2 pcs super bright LED.
- Material: PS Lens and PP Base
- Power: 1 or 2 pcs 4R25 6V Battery
- Blink Frequency: 70±5 times/min
- Inside switch with photosensor make the light dusk ON and dawn OFF

PART NO	PCS / PKT	PCS / CTN
U6305 (WITH BRACKET)	1	12
U6306 (WITHOUT BRACKET)	1	12

ROAD LIGHT - SINGLE



HIGHLIGHTS

- 6 pcs super bright LED
- Material: PC Lens and PP Base
- Power: 1 pcs 4R25 6V Battery
- Blink Frequency: 70±5 times/min
- ON/OFF by rotation of the len
- Photosensor make the light dusk ON and dawn OFF

PART NO	PCS / PKT	PCS / CTN
U6307	1	8

ROAD LIGHT - ROUND SOLAR CONE TYPE



HIGHLIGHTS

- 6 pcs super bright LED
- Solar panel power: 0.4W (8 hours recharged can work 120-150 hours)
- 2.4V 100mAh, AA Ni-NH rechargeable battery
- Blink Frequency: 70±5 times/min
- Inside switch with photocell make the light dusk and dawn off
- Special base can fix to any traffic cone easily

PART NO	PCS / PKT	PCS / CTN
U6308	1	10

ROAD LIGHT - SOLAR WITH BRACKET



HIGHLIGHTS

- 4 pcs super bright LED
- Material: PS Lens and PP Base
- Power: 0.4W (8 hours recharged can work 120-150 hours)
- 1.2V 100mAh, AA Ni-NH rechargeable battery
- Blink Frequency: 70±5 times/min
- Inside switch with photosensor make the Light duck ON and dawn OFF
- Photosensor make the light dusk ON and dawn OFF
- Lock metal bracket is available

PART NO	PCS / PKT	PCS / CTN
U6309	1	12

BATTERY -6V



HIGHLIGHTS

- 4R25 6V Battery
- Used for warning light

PART NO	DESCRIPTION	PCS / PKT	PCS / CTN
B6VT	6V	1	24

GLOVES LATEX - BLUE GRIP



HIGHLIGHTS

- 10G High grade polyester shell, latex coated, crinkle finish
- Excellent flexible and comfortable good grip and anti-slip
- Suitable for industrial purpose

PART NO	PCS / PKT	PCS / CTN
U5000	1 DOZ	10 DOZ

GLOVES LATEX - BLUE GRIP HALF COATED



HIGHLIGHTS

- 10G T/C shell latex 3/4 coated crinkle finish
- Flexible and comfortable
- Good grip
- Suitable for all industries

PART NO	PCS / PKT	PCS / CTN
U5007	1 DOZ	10 DOZ

GLOVES - WHITE GRIP



HIGHLIGHTS

- 13G, Polyester shell, pre dots coated
- Flexible and comfortable
- Excelent breathability
- Anti-slip and abrasion resistance
- Wide range application

PART NO	PCS / PKT	PCS / CTN
U5004	1 DOZ	20 DOZ

GLOVES - BLACK GRIP



HIGHLIGHTS

- 13g polyester shell, pvc coated flexible and good feeling
- Excellent elastic, micropure structure Antistatic
- Suitable for Electronic, precision instrument assembly

PART NO	PCS / PKT	PCS / CTN
U5003	1 DOZ	20 DOZ

GLOVES NITRILE - GREEN GRIP



HIGHLIGHTS

- 15G Nylon shell nitrile coated
- High flexible and super comfortable
- Excelent breathability
- Suitable for chemical and paint work maintenance

PART NO	PCS / PKT	PCS / CTN
U5001	1 DOZ	20 DOZ

GLOVES - DOTTED DOUBLE SIDE - BLACK



HIGHLIGHTS

- 10G Polyester shell, pvc dots coated double sides
- Flexible and comfortable
- Excellent breathability
- Anti slip and abrasion resistance
- Wide range of applications

PART NO	PCS / PKT	PCS / CTN
U5005	1 DOZ	20 DOZ

GLOVES - DOTTED SINGLE SIDE - BLACK



HIGHLIGHTS

- 10GT/s Polyester shell, pvc dots coated double sides
- Flexible and comfortable
- Excellent breathability
- Anti slip and abrasion resistance
- Wide range of applications

PART NO	PCS / PKT	PCS / CTN
U5006	1 DOZ	20 DOZ

GLOVES - WHITE WITH PVC DOT



HIGHLIGHTS

- 13g polyester shell, pvc coated flexible and good feeling
- Excellent elastic, micropure structure Antistatic
- Suitable for Electronic, precision instrument assembly

PART NO	PCS / PKT	PCS / CTN
U5002	1 DOZ	20 DOZ

DUST MASK



HIGHLIGHTS

- Light Weight
- Metal Nose Clip to fit individual facial contours
- Does not impair breathing, voice and vision
- No interference with glasses

PART NO	PCS / PKT	PCS / CTN
U3900	1 PKT / 45 PCS	20 PKT

MASK - RESPIRATOR - N95



HIGHLIGHTS

- Light Weight
- Metal Nose Clips
- Easy breathing/speaking and clear vision
- Approved by NIOSH

PART NO	PCS / PKT	PCS / CTN
U3901	1 PKT / 20 PCS	8 PKT



WELDING OVEN



HIGHLIGHTS

- High Strength
- Rust Resistance
- Durability

PART NO	DESCRIPTION	PCS / PKT	PCS / CTN
U4907	VOLTAGE: 60V - 120V AC/ DC 240 V AC TEMPERATURE RANGE: 150°C THERMOSTAT: PRESENT HEATING ELEMENT: 120W / 270W WIRE WRAP CAPACITY: 5 KG	1	6

PART NO	DESCRIPTION	PCS / PKT	PCS / CTN
U4910	INPUT VOLTAGE: 220 - 240 V AC 200 WATTS TEMPERATURE RANGE - 120° MAX CAPACITY - 9 KG	1	6

PART NO	DESCRIPTION	PCS / PKT	PCS / CTN
U4911	INPUT VOLTAGE: 110V - 120V 200 WATTS TEMPERATURE RANGE: 120° MAX CAPACITY: 9 KG	1	6

PART NO	DESCRIPTION	PCS / PKT	PCS / CTN
U4908	INPUT VOLTAGE: 220V - 240V 780 WATTS TEMPERATURE RANGE: 50°C - 150°C LENGTH: 450 MM CAPACITY: 10 KG	1	4

WELDING HOLDER

HIGHLIGHTS

- High-tensile, heat insulated handle
- Mechanical and thermal heavy-duty
- Insulating material
- Big electrode and welding connection area

PART NO	DESCRIPTION	PCS / PKT	PCS / CTN
U4901	600A	1	50
U4900	600A HEAVY DUTY	1	30



EARTH CLAMP

HIGHLIGHTS

- Crocodile earth clamp welder for mig, tig & plasma welding
- 500 Amp welding cable



PART NO	DESCRIPTION	PCS / PKT	PCS / CTN
U4902	500 AMP	1	50



HIGHLIGHTS

- British screw earth clamp heavy duty 600Amp
- Brass material heavy duty

PART NO	DESCRIPTION	PCS / PKT	PCS / CTN
U4906	600A SCREW TYPE	1	20

WELDING CABLE CONNECTOR

HIGHLIGHTS

- Safe and quick connection
- High flash-over resistance - maximum machine protection
- Easy mounting, optimal connection and very good power transmission



PART NO	DESCRIPTION	SET / PKT	SET / CTN
U4903	35-50 MM	1	84
U4904	50-70 MM	1	84
U4905	70-90MM	1	84

WELDING LIGHTER

HIGHLIGHTS

- Tripple flint lighter for welders and platters



PART NO	PCS / PKT	PCS / CTN
U4915	1	200

FLINT STONE

HIGHLIGHTS

- Tripple flint Stone, Material : Steel



PART NO	DESCRIPTION	PCS / PKT	PCS / CTN
U4916	3 STONES	5	160

WELDING HELMET - AUTO DARKENING

HIGHLIGHTS

- Suitable for ARC/MIG/TIG welding
- High strength mask material
- High clear view filter



PART NO	DESCRIPTION	PCS / PKT	PCS / CTN
U4909	SOLAR POWERED	1	6

WELDING CHIPPING HAMMER

HIGHLIGHTS

- Induction hardened head, drop forged
- Steel handle with spring grip



PART NO	DESCRIPTION	PCS / PKT	PCS / CTN
UH24500	500 G	1	50

HOSE CLIP

HIGHLIGHTS

- Ideally Suited for most day to day requirements for joining hose in all the general purpose areas



PART NO	DESCRIPTION	PCS / PKT	PCS / CTN
U51-000	12 MM	10	1000
U51-M00	16 MM	10	1000
U51-00	20 MM	10	800
U51-0	22 MM	10	800
U51-0X	25 MM	10	800
U51-1A	30 MM	10	800
U51-1	35 MM	10	800
U51-1X	40 MM	10	800
U51-1M	45 MM	10	600
U51-2A	50 MM	10	600
U51-2	55 MM	10	600
U51-2X	60 MM	10	400
U51-3	70 MM	10	400
U51-3X	80 MM	10	200
U51-4	90 MM	10	200
U51-4X	100 MM	10	200
U51-5	120 MM	10	100
U51-6	140 MM	10	100
U51-6X	150 MM	10	100
U51-7	165 MM	10	100
U51-7.5	190 MM	10	100
U51-8.5	216 MM	10	50
U51-9.5	242 MM	10	50
U51-10.5	267 MM	10	25
U51-11.5	292 MM	10	25
U51-12.5	318 MM	10	25

HOSE CLIP - STAINLESS STEEL



HIGHLIGHTS

- Hose clips in 304 stainless steel are widely used across all industries where hose clips are used to secure hoses, as well as for other application
- Corrosion resistance

PART NO	DESCRIPTION	PCS / PKT	PCS / CTN
U52-000	12 MM	10	1000
U52-M00	16 MM	10	1000
U52-00	20 MM	10	800
U52-0	22 MM	10	800
U52-0X	25 MM	10	800
U52-1A	30 MM	10	800
U52-1	35 MM	10	800
U52-1X	40 MM	10	800
U52-1M	45 MM	10	600
U52-2A	50 MM	10	600
U52-2	55 MM	10	600
U52-2X	60 MM	10	400
U52-3	70 MM	10	400
U52-3X	80 MM	10	200
U52-4	90 MM	10	200
U52-4X	100 MM	10	200
U52-5	120 MM	10	100
U52-6	140 MM	10	100
U52-6X	150 MM	10	100
U52-7	165 MM	10	100
U52-7.5	190 MM	10	100
U52-8.5	216 MM	10	50
U52-9.5	242 MM	10	50
U52-10.5	267 MM	10	25
U52-11.5	292 MM	10	25
U52-12.5	318 MM	10	25





CHAIN PULLY BLOCK



HIGHLIGHTS

- Japan Model
- Load limiter is available at extra cost
- Low effort to lift maximum load
- Automatic double pawl braking system
- Premium grade alloy load chain and zinc plated hand chain as standard
- Drop-forged and expertly heat treated hooks for great strength and long wearing
- Capacity ranges from 0.5t to 20t, heavy duty 30t, 50t is available

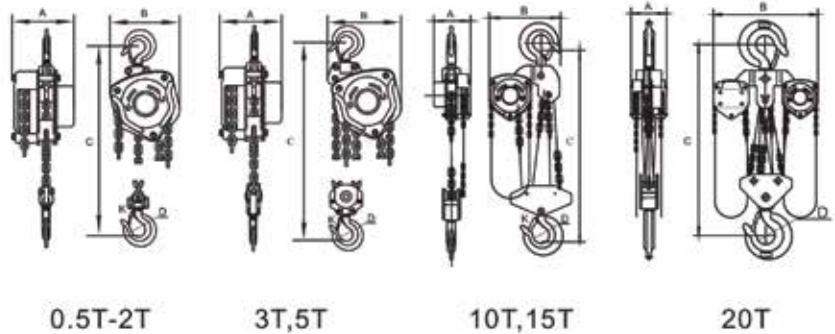

MODEL		U5800	U5801	U5802	U5803	U5804
CAPACITY	TONS	1	2	3	5	10
STANDARD LIFT	M	3	3	3	3	6
RUNNING TEST LOAD	KN	15	45	45	62.5	125
EFFORT REQUIRED TO LIFT RATED LOAD	N	320	365	385	435	435
STRANDS OF LOAD CHAIN		1	1	2	2	4
DIAMETER OF LOAD CHAIN	MM	6	8	7.1	9	9
DIMENSIONS (MM)	A	140	161	161	186	207
	B	158	187	210	253	398
	C	317	414	465	636	798
	D	40	50	58	64	85
	K	34	41	48	52	64
NET WEIGHT	KG	11	18.5	25.6	42.8	79.5
PACKING MEASUREMENT	CM	23 X 18 X 19.5	28 X 21 X 24	32 X 21 X 26	40 X 21 X 21	64 X 21 X 21
EXTRA WEIGHT PER METRE OF EXTRA LIFT	KG	1.7	2.3	3.7	5.6	9.7

CHAIN PULLY BLOCK

HIGHLIGHTS

- Japan model
- Load limiter is available at extra cost
- Low effort to lift maximum load
- Automatic double pawl braking system
- Premium grade alloy load chain and zinc plated hand chain as standard
- Drop-forged and expertly heat treated hooks for great strength and low wearing
- Capacity ranges from 0.5 to 20t, heavy duty 30t and 50t is available



PART NO	DESCRIPTION	PCS / CTN
U5805	1.5T X 3.0M	7.1MM X 21MM X 1
U5811	2.0T X 6.0M	8MM X 24MM X 1
U5812	3.0T X 6.0M	7.1MM X 21MM X 2
U5813	5.0T X 6.0M	9MM X 27MM X 2
U5821	5.0T X 10M	9MM X 27MM X 2
U5822	10T X 10M	9MM X 27MM X 4

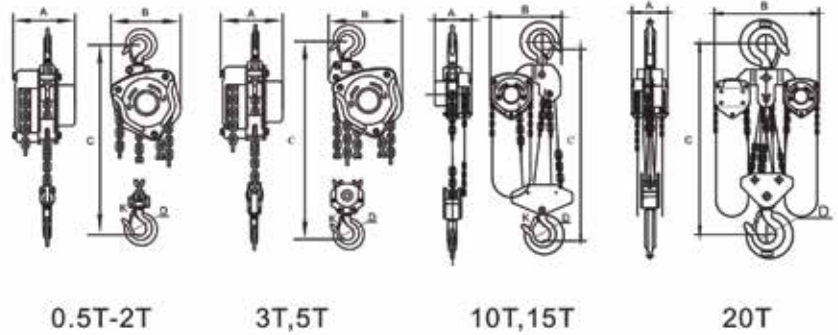

0.5T-2T

3T,5T

10T,15T

20T



LEVER BLOCK / LEVER HOIST

HIGHLIGHTS

- German model, heavy duty type
- Compact design and robust, deep drawn, stamped steel construction
- High quality material ensure light weight without infringing reliability
- Low weight, small mounting sizes and small lever forces at full load
- Short hand lever with rubber grip
- Premium grade alloy load chain
- Drop-forged and expertly heat treated hooks for great strength and long wearing
- Capacity ranges from 0.75t to 9t
- Different lifting length is available at requirement

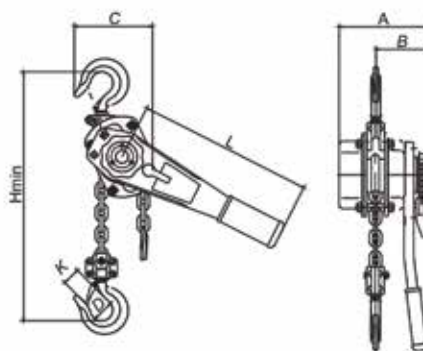

MODEL		U5830	U5831	U5832	U5833	U5834
CAPACITY	TONS	0.75	1.5	3.0	6.0	1
STANDARD LIFT	M	1.5	1.5	1.5	1.5	1.5
RUNNING TEST LOAD	KN	12	24	45	94.5	15
EFFORT REQUIRED TO LIFT RATED LOAD	N	140	220	320	340	140
STRANDS OF LOAD CHAIN		1	1	1	2	1
DIAMETER OF LOAD CHAIN	MM	6	8	10	10	6
DIMENSIONS (MM)	A	145	175	203	203	145
	B	86	100	118	118	86
	C	122	130	150	205	134
	D	37	45	50	64	38
	H	320	380	480	620	340
	L	280	410	410	410	285
	K	30	36	40	50	27
NET WEIGHT	KG	7	11	21	31	9.5
PACKING MEASUREMENT	CM	36 X 12.5 X 16	50 X 13.5 X 19	54 X 17 X 21.5	54 X 18 X 21.5	37.5 X 16 X 8
EXTRA WEIGHT PER METRE OF EXTRA LIFT	KG	0.8	1.4	2.2	4.4	0.8

PALLET TRUCK

HIGHLIGHTS

- Easy to operate
- Silent in operation, no oil leakage
- Minimum maintenance
- Can enter pallet from all 4 sides

PART NO	DESCRIPTION	PCS / PKT	PCS / CTN
U2500	2.5 TON (540X1150)	1	1
U3000	3 TON (540X1150)	1	1

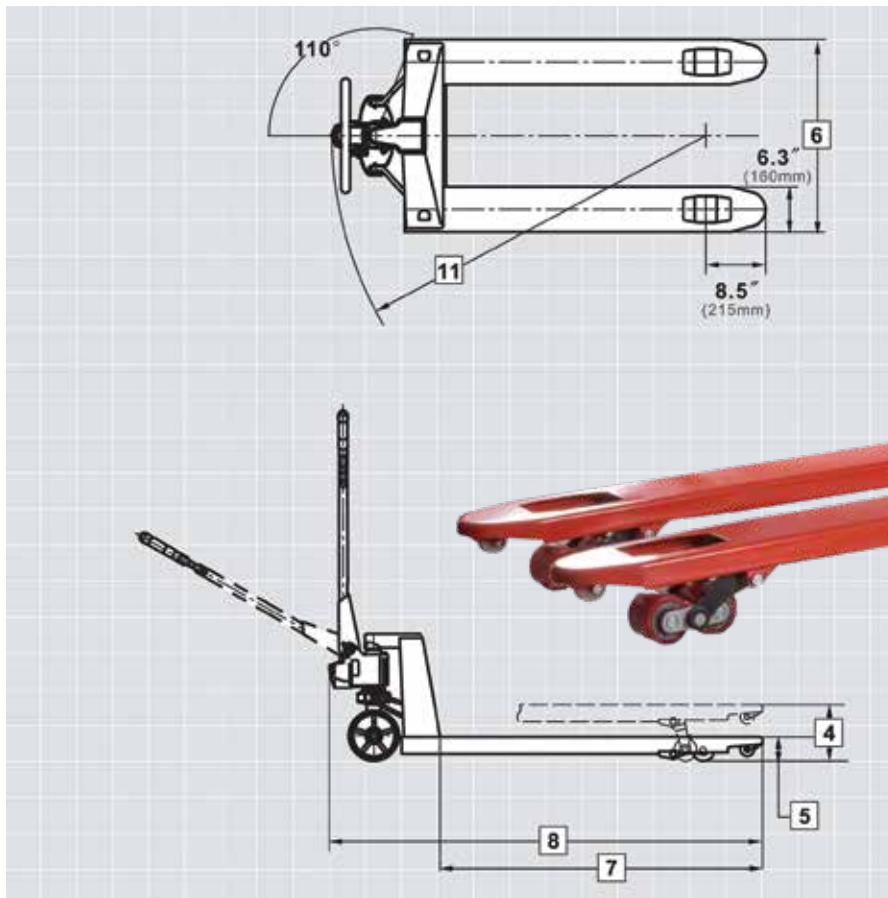

METRIC

	1	2	3	4	5	6	7	8	9	10	11
GENERAL	1	BRAND		UKEN							
	2	MODEL		U2000 / U2500 / U3000							
	3	LOAD CAPACITY	LB. KG	2000 / 2500 / 3000							
DIMENSIONS	4	LIFT HEIGHT	IN. MM	200 / 190							
	5	MIN. HEIGHT	IN. MM	75 / 85							
	6	OUTSIDE FORK SPREAD	IN. MM	450 / 520 / 540 / 685							
	7	FORK LENGTH	IN. MM	800 / 900 / 1000 / 1100 / 1150 / 1220							
FORKS	8	OVERALL LENGTH	IN. MM	1230 / 1330 / 1430 / 1530 / 1580 / 1650							
	9	STEERING WHEEL	IN. MM	∅ 180 X 50 / 200 X 50							
	10	LOAD ROLLER	IN. MM	∅ 80 X 70 / 70 X 70							
	11	TURNING RADIUS	IN. MM	1250							





CASTER WHEEL - RUBBER FIXED



HIGHLIGHTS

- Noise Reduction
- Ergonomics
- Surface Protection
- Better Towing Capabilities
- Long life
- Corrosion Resistant

								PCS / PKT	PCS / CTN
U5340F	54	40 X 17	45 X 40	35 X 28.5	5	20	4	280	
U5350F	65	50 X 22	58 X 48	46 X 35	6	25	4	120	
U5365F	84	65 X 23	65 X 54	51 X 38	7	30	4	120	
U5303F	108	80X27	105X88	80X60	14X9	70	1	42	
U5304F	128	100X30	105X88	80X60	14X9	100	1	34	
U5305F	155	125X38	105X88	80X60	14X9	150	1	24	
U5306F	195	160X50	135X114	105X80	16X11	180	1	10	
U5308F	240	200X50	135X114	105X80	16X11	200	1	8	

CASTER WHEEL - RUBBER SWIVEL

HIGHLIGHTS

- Noise Reduction
- Ergonomics
- Surface Protection
- Better Towing Capabilities
- Long life
- Corrosion Resistant

								PCS / PKT	PCS / CTN
U5340S	54	40 X 17	17	45 X 40	35 X 28.5	5	20	4	288
U5350S	65	50 X 22	22	58 X 48	46 X 35	6	25	4	120
U5365S	84	65 X 23	25	65 X 54	51 X 38	7	30	4	120
U5303S	108	80X27	37	105X85	80X60	14X9	70	1	42
U5304S	128	100X30	37	105X85	80X60	14X9	100	1	34
U5305S	155	125X38	37	105X85	80X60	14X9	150	1	20
U5306S	195	160X50	55	135X110	105X80	16X11	180	1	10
U5308S	240	200X50	55	135X110	105X80	16X11	200	1	8



CASTER WHEEL - RUBBER SWIVEL WITH BRAKE

HIGHLIGHTS

- Noise Reduction
- Ergonomics
- Surface Protection
- Better Towing Capabilities
- Long life
- Corrosion Resistant



								PCS / PKT	PCS / CTN
U5340B	54	40 X 17	17	45 X 40	35 X 28.5	5	20	4	288
U5350B	65	50 X 22	22	58 X 48	46 X 35	6	25	4	120
U5365B	84	65 X 23	25	65 X 54	51 X 38	7	30	4	120
U5303B	108	80X27	37	105X85	80X60	14X9	70	1	36
U5304B	128	100X30	37	105X85	80X60	14X9	100	1	30
U5305B	155	125X38	37	105X85	80X60	14X9	150	1	20
U5306B	195	160X50	55	135X110	105X80	16X11	180	1	10
U5308B	240	200X50	55	135X110	105X80	16X11	200	1	6

CASTER WHEEL - NYLON SWIVEL FIXED

HIGHLIGHTS

- Noise Reduction
- Ergonomics
- Surface Protection
- Better Towing Capabilities
- Long life
- Corrosion Resistant



								PCS / PKT	PCS / CTN
U5403F	108	80X30	105X88	80X60	14X9	100	1	42	
U5404F	128	100X30	105X88	80X60	14X9	120	1	34	
U5405F	155	125X30	105X88	80X60	14X9	150	1	24	
U5406F	195	160X50	135X114	105X80	16X11	200	1	10	
U5408F	240	200X50	135X114	105X80	16X11	250	1	8	
U5440F	54	40X17	45X40	35X28.5	5	20	4	288	
U5450F	65	50X22	58X40	46X35	6	25	4	120	
U5465F	84	65X23	65X54	51X38	7	30	4	120	

CASTER WHEEL - NYLON SWIVEL

HIGHLIGHTS

- Noise Reduction
- Ergonomics
- Surface Protection
- Better Towing Capabilities
- Long life
- Corrosion Resistant

								PCS / PKT	PCS / CTN
U5403S	108	80X30	37	105X85	80X60	14X9	100	1	42
U5404S	128	100X30	37	105X85	80X60	14X9	120	1	34
U5405S	155	125X38	37	105X85	80X60	14X9	150	1	20
U5406S	195	160X45	55	135X110	105X80	16X11	200	1	10
U5408S	240	200X50	55	135X110	105X80	16X11	250	1	8
U5440S	54	40X17	17	45X40	35X28.5	5	20	4	288
U5450S	65	50X22	22	58X40	46X35	6	25	4	120
U5465S	84	65X23	25	65X54	51X38	7	30	4	120



CASTER WHEEL - NYLON SWIVEL WITH BRAKE

HIGHLIGHTS

- Noise Reduction
- Ergonomics
- Surface Protection
- Better Towing Capabilities
- Long life
- Corrosion Resistant













								PCS / PKT	PCS / CTN
U5403B	108	80X30	37	105X85	80X60	14X9	100	1	36
U5404B	128	100X30	37	105X85	80X60	14X9	120	1	30
U5405B	155	125X30	37	105X85	80X60	14X9	150	1	20
U5406B	195	160X45	55	135X110	105X80	16X11	200	1	10
U5408B	240	200X50	55	135X110	105X80	16X11	250	1	6
U5440B	54	40X17	17	45X40	35X28.5	5	20	4	288
U5450B	65	50X22	22	58X40	46X35	6	25	4	120
U5465B	84	65X23	25	65X54	51X38	7	30	4	120



RUBBER CASTER WHEEL - EUROPEAN TYPE

HIGHLIGHTS

- Smooth and silent running
- Highli resilient tread
- Elastic rubber
- Used for concrete floor and in plant tar roads etc

						PCS / PKT	PCS / CTN
U5303RR	80X27	40	12		70	1	130
U5304RR	100X30	40	12		100	1	80
U5305RR	125X38	40	12		150	1	50
U5306RR	160X50	60	20		180	1	20
U5308RR	200X50	60	20		200	1	13



SCAFFOLDING WHEEL WITH TUBE

HIGHLIGHTS

- Scaffolding wheels 6" & 8" with solid round tube
- The wheel swivel 360 degree and equipped with wheel locking brakes

PART NO	DESCRIPTION	PCS / PKT	PCS / CTN
U5316T	6"	1	6
U5320T	8"	1	4



SCAFFOLDING WHEEL WITH STEM

HIGHLIGHTS

- Scaffolding wheels 6" & 8" with solid round stem
- The wheel swivel 360 degree and equipped with wheel locking brakes

PART NO	DESCRIPTION	PCS / PKT	PCS / CTN
U5316R	6"	1	6
U5320R	8"	1	4





EXHAUST FAN ROUND

HIGHLIGHTS

- High air delivery
- Made of special grade plastics
- Unparalleled cost v/s value in its class
- Ideal for kitchen and bathrooms

PART NO	DESCRIPTION	PCS / PKT	PCS / CTN
APC15G1	6" ROUND VOL./FREQ: 220V/50HZ POWER 15W	1	18
APC20G1	8" ROUND VOL./FREQ: 220V/50HZ POWER 15W	1	12

EXHAUST FAN ROUND - HEAVY DUTY

PART NO	DESCRIPTION	PCS / PKT	PCS / CTN
APC15G2	6" ROUND HEAVY DUTY VOL./FREQ: 220V/50HZ POWER 20W	1	24
APC20G2	8" ROUND HEAVY DUTY VOL./FREQ: 220V/50HZ POWER 20W	1	14

EXHAUST FAN SQUARE-AUTO SHUTTER ABS

HIGHLIGHTS

PART NO	DESCRIPTION	PCS / PKT	PCS / CTN
APC15E1	6" SQUARE VOL./FREQ: 220V/50HZ POWER 23W	1	8
APC20E1	8" ROUND VOL./FREQ: 220V/50HZ POWER 28W	1	6



NYLON TOGGLE ANCHOR

HIGHLIGHTS

- In solid base materials, the anchor can be used by removing the outer wings
- The Nylon Toggle Anchor is designed to develop a triangulated clamp behind the wall of the hollow base material
- High quality Nylon ensures resistance to ageing, chemicals, rust and weathering

APPLICATION

For fixing light weight objects to the above mentioned materials with the help of wood, chipboard or self tapping screws. For eg:

1. Window treatments
2. Towel Bars
3. Kitchen Accessories
4. Smoke Detectors
5. Telephone equipment
6. Shelving
7. Lighting fixtures
8. Signs
9. Mirrors
10. Soap Dispensers

TECHNICAL DESCRIPTION

Suitable for:

1. Drywall
2. Gypsum Board
3. Plaster Board
4. Hollow Core Doors

PART NO	SIZE	HOLE SIZE	PCS / PKT	PCS / CTN
UF2021	1/8"-1/4" (14*18MM)	5/16(8MM)	100	60
UF2022	3/8"-1/2" (14*25MM)	5/16(8MM)	100	30
UF2023	5/8"-3/4" (14*35MM)	5/16(8MM)	100	30





NYLON WALL PLUG

HIGHLIGHTS

- Simple and Quick Installation
- High quality Nylon ensures resistance to ageing, chemicals, rust and weathering
- Wings (also known as anti-rotation lugs) prevent rotation inside once installed
- Ensures elastic fixing compatible with porcelain without
- Leaves an attractive clean finish damaging it.

NYLON WALL PLUG

APPLICATIONS

- For fixing light weight objects to the above mentioned materials with the help of wood, chipboard or self tapping screws. For eg.
 1. Frames
 2. Switches
 3. Curtain Rails
 4. Light Weight Shelves
 5. Hanging Lamps

TECHNICAL DESCRIPTION

Suitable for:

1. Concrete
2. Hollow Concrete Blocks
3. Solid Bricks
4. Natural Stone

PART NO	SIZE	LENGTH (MM)	RECOMMENDED LOAD (KN)	PCS / PKT	PCS / CTN
UF1010	M5	25	0.2	100	200
UF1011	M6	30	0.3	100	200
UF1012	M7	35	0.4	100	100
UF1013	M8	40	0.5	100	100
UF1014	M10	50	1.04	50	100
UF1015	M12	60	1.6	25	100
UF1016	M14	75	1.96	20	100
UF1017	M16	80	2.38	12	100





CONCEALED HINGE / HYDRAULIC

HIGHLIGHTS

- Automatic closing (buffering oil equipment)
- Opening angle 100 degree
- Diameter of hing cup-35mm
- Door (c) dimension : 3-7
- Door thickness :15-21mm
- Optional instalation of hing cup distance (45/48/52mm)
- Cup thickness 9.5mm/11.5mm

PART NO	DESCRIPTION	PCS / PKT	PCS / CTN
UI-041	STRAIGHT	10	100
UI-042	HALF BEND	10	100
UI-043	FULL BEND	10	100

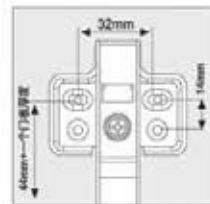
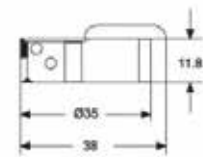
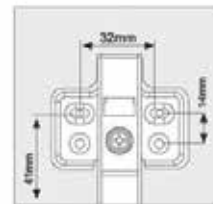
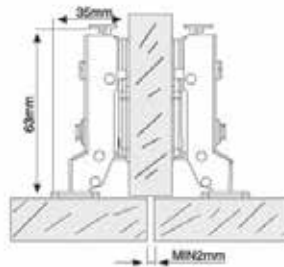
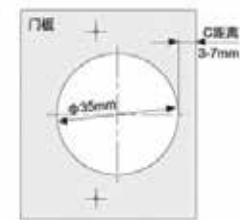
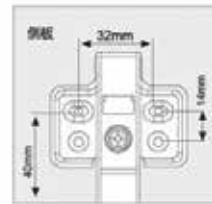
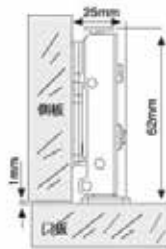

DOOR LOCK BODY

HIGHLIGHTS

- Latch & dead bolt:Stainless Steel.304
- Suitable for residential project

PART NO	DESCRIPTION	PCS / PKT	PKT / CTN
UI-001	45 X 85 SS	1	25
UI-002	40 X 85 SS	1	25
UI-003	35 X 85 SS	1	36
UI-004	25 X 85 SS	1	36

DOOR CLOSER

HIGHLIGHTS

- Hold open facility
- Door width-900 to 1300mm
- Door opening angle-180 max
- Two hydrolic pressure valves control
- Two sections of door closing seperately,the speed of locking control by the whole section of the hydrolic pressure



DOOR CLOSER GOLD

PART NO	DESCRIPTION	PCS / PKT	PKT / CTN
UI-031G	45 - 60 KG	1	10
UI-032G	60 - 75 KG	1	10
UI-033G	70 - 90 KG	1	10



DOOR CLOSER SILVER

PART NO	DESCRIPTION	PCS / PKT	PKT / CTN
UI-031S	45 - 60 KG	1	10
UI-032S	60 - 75 KG	1	10
UI-033S	70 - 90 KG	1	10



DOOR CLOSER WHITE

PART NO	DESCRIPTION	PCS / PKT	PKT / CTN
UI-031W	45 - 60 KG	1	10
UI-032W	60 - 75 KG	1	10
UI-033W	70 - 90 KG	1	10

BALL BEARING HINGES



HIGHLIGHTS

- Suitable for doors upto 80 kg
- Tested to 200,000 Cycles
- 102 MM x 76 MM - pair
- Material SS304
- Stainless Steel brush finish
- Screws included

PART NO	DESCRIPTION	PCS / PKT	PKT / CTN
UI-045	4" SS304 SSB	1 PAIR	50

DOOR CYLINDER

HIGHLIGHTS

- Strengthening bar provides additional Strength against physical attacks
- Grip deflectors make it difficult to grip the cylinder and protects against physical attack with tools
- Available in Euro Single & Double Cylinders
- 3 key Supplied

PART NO	DESCRIPTION	PCS / PKT	PCS / CTN
UI-021	61 MM	10	60
UI-023	70 MM	10	60

DOOR CYLINDER WITH KNOB

PART NO	DESCRIPTION	PCS / PKT	PCS / CTN
UI-022	61 MM	10	60
UI-024	70 MM	10	60





PADLOCK

HIGHLIGHTS

- Body material-solid brass / steel shackle
- No of keys: 3

PART NO	BODY WIDTH	LOCK LEVER	PCS / PKT	PKT / CTN
UI-201	20 MM	SINGLE LOCK	6	180
UI-202	25 MM	SINGLE LOCK	6	180



PADLOCK

HIGHLIGHTS

- Body material-solid brass / Cut resistant hardened steel shackle
- Pin Tumbler Cylinder for increased resistance to picking
- No of keys: 3

PART NO	BODY WIDTH	LOCK LEVER	PCS / PKT	PKT / CTN
UI-203	30 MM	DOUBLE LOCK	6	180
UI-204	40 MM	DOUBLE LOCK	6	120
UI-205	50 MM	DOUBLE LOCK	6	72
UI-206	60 MM	DOUBLE LOCK	6	36
UI-207	70 MM	DOUBLE LOCK	6	24



PADLOCK LONG SHACKLE

HIGHLIGHTS

- Double locking shackle
- Pin Tumbler Cylinder for increased resistance to picking
- Body material-solid brass / Cut resistant hardened steel
- No of keys: 3

PART NO	BODY WIDTH	LOCK LEVER	PCS / PKT	PKT / CTN
UI-222	30 MM L	DOUBLE LOCK	6	180
UI-223	40 MM L	DOUBLE LOCK	6	120
UI-224	50 MM L	DOUBLE LOCK	6	36



COMBINATION PADLOCK

HIGHLIGHTS

- Single locking shackle
- Body material solid brass with steel shackle

PART NO	BODY WIDTH	LOCK LEVER	PCS / PKT	PKT / CTN
UI-321	20 X 4	SINGLE LOCK	6	72

Rechargeable LED Flash light
with Air craft Aluminium
body



RECHARGEABLE LED FLASH LIGHT

SPECIFICATION

Rechargeable LED Flash light
with Air craft Aluminium body

Operating Time 2.5 Hours

1300mAh Ni-Cd

Part No	Pcs/Pkt	Pcs/Ctn
UG 001	1	20



